

ONKYO®

AV Receiver

TX-L55

Instruction Manual

Thank you for purchasing an Onkyo AV Receiver. Please read this manual thoroughly before making connections and plugging in the unit. Following the instructions in this manual will enable you to obtain optimum performance and listening enjoyment from your new AV Receiver. Please retain this manual for future reference.

Contents

Introduction 2

Connections 16

Basic Setup 30

Basic Operation 33

Advanced Operation 44

Advanced Setup 48

**Controlling Other
Components 55**

Troubleshooting 59

Specifications..... 62

WARNING:

TO REDUCE THE RISK OF FIRE OR ELECTRIC SHOCK, DO NOT EXPOSE THIS APPARATUS TO RAIN OR MOISTURE.

CAUTION:

TO REDUCE THE RISK OF ELECTRIC SHOCK, DO NOT REMOVE COVER (OR BACK). NO USER-SERVICEABLE PARTS INSIDE. REFER SERVICING TO QUALIFIED SERVICE PERSONNEL.



WARNING
RISK OF ELECTRIC SHOCK
DO NOT OPEN

AVIS
RISQUE DE CHOC ELECTRIQUE
NE PAS OUVRIR



The lightning flash with arrowhead symbol, within an equilateral triangle, is intended to alert the user to the presence of uninsulated "dangerous voltage" within the product's enclosure that may be of sufficient magnitude to constitute a risk of electric shock to persons.



The exclamation point within an equilateral triangle is intended to alert the user to the presence of important operating and maintenance (servicing) instructions in the literature accompanying the appliance.

Important Safety Instructions

1. Read these instructions.
2. Keep these instructions.
3. Heed all warnings.
4. Follow all instructions.
5. Do not use this apparatus near water.
6. Clean only with dry cloth.
7. Do not block any ventilation openings. Install in accordance with the manufacturer's instructions.
8. Do not install near any heat sources such as radiators, heat registers, stoves, or other apparatus (including amplifiers) that produce heat.
9. Do not defeat the safety purpose of the polarized or grounding-type plug. A polarized plug has two blades with one wider than the other. A grounding type plug has two blades and a third grounding prong. The wide blade or the third prong are provided for your safety. If the provided plug does not fit into your outlet, consult an electrician for replacement of the obsolete outlet.
10. Protect the power cord from being walked on or pinched particularly at plugs, convenience receptacles, and the point where they exit from the apparatus.
11. Only use attachments/accessories specified by the manufacturer.
12. Use only with the cart, stand, tripod, bracket, or table specified by the manufacturer, or sold with the apparatus. When a cart is used, use caution when moving the cart/apparatus combination to avoid injury from tip-over.

PORTABLE CART WARNING



S3125A
13. Unplug this apparatus during lightning storms or when unused for long periods of time.
14. Refer all servicing to qualified service personnel. Servicing is required when the apparatus has been damaged in any way, such as power-supply cord or plug is damaged, liquid has been spilled or objects have fallen into the apparatus, the apparatus has been exposed to rain or moisture, does not operate normally, or has been dropped.
15. Damage Requiring Service

Unplug the apparatus from the wall outlet and refer servicing to qualified service personnel under the following conditions:

 - A. When the power-supply cord or plug is damaged,
 - B. If liquid has been spilled, or objects have fallen into the apparatus,
 - C. If the apparatus has been exposed to rain or water,
 - D. If the apparatus does not operate normally by following the operating instructions. Adjust only those controls that are covered by the operating instructions as an improper adjustment of other controls may result in damage and will often require extensive work by a qualified technician to restore the apparatus to its normal operation,
 - E. If the apparatus has been dropped or damaged in any way, and
 - F. When the apparatus exhibits a distinct change in performance this indicates a need for service.
16. Object and Liquid Entry

Never push objects of any kind into the apparatus through openings as they may touch dangerous voltage points or short-out parts that could result in a fire or electric shock.

The apparatus shall not be exposed to dripping or splashing and no objects filled with liquids, such as vases shall be placed on the apparatus.

Don't put candles or other burning objects on top of this unit.
17. Batteries

Always consider the environmental issues and follow local regulations when disposing of batteries.
18. If you install the apparatus in a built-in installation, such as a bookcase or rack, ensure that there is adequate ventilation.

Leave 20 cm (8") of free space at the top and sides and 10 cm (4") at the rear. The rear edge of the shelf or board above the apparatus shall be set 10 cm (4") away from the rear panel or wall, creating a flue-like gap for warm air to escape.

Precautions

- 1. Recording Copyright**—Unless it's for personal use only, recording copyrighted material is illegal without the permission of the copyright holder.
- 2. AC Fuse**—The AC fuse inside the TX-L55 is not user-serviceable. If you cannot turn on the TX-L55, contact your Onkyo dealer.
- 3. Care**—Occasionally you should dust the TX-L55 all over with a soft cloth. For stubborn stains, use a soft cloth dampened with a weak solution of mild detergent and water. Dry the TX-L55 immediately afterwards with a clean cloth. Don't use abrasive cloths, thinners, alcohol, or other chemical solvents, because they may damage the finish or remove the panel lettering.

4. Power

WARNING

BEFORE PLUGGING IN THE UNIT FOR THE FIRST TIME, READ THE FOLLOWING SECTION CAREFULLY.

AC outlet voltages vary from country to country. Make sure that the voltage in your area meets the voltage requirements printed on the TX-L55's rear panel (e.g., AC 230 V, 50 Hz or AC 120 V, 60 Hz).

Setting the [STANDBY/ON] button to STANDBY does not fully shutdown the TX-L55. If you do not intend to use the TX-L55 for an extended period, remove the power cord from the AC outlet.

Memory backup

The TX-L55 uses a battery-less memory backup system in order to retain radio presets and other settings when it's unplugged or in the case of a power failure.

Although no batteries are required, the TX-L55 must be plugged into an AC outlet in order to charge the backup system.

Once it has been charged, the TX-L55 will retain the settings for several weeks, although this depends on the environment and will be shorter in humid climates.

For British models

Replacement and mounting of an AC plug on the power supply cord of this unit should be performed only by qualified service personnel.

IMPORTANT

The wires in the mains lead are coloured in accordance with the following code:

Blue: Neutral
Brown: Live

As the colours of the wires in the mains lead of this apparatus may not correspond with the coloured markings identifying the terminals in your plug, proceed as follows:

The wire which is coloured blue must be connected to the terminal which is marked with the letter N or coloured black.

The wire which is coloured brown must be connected to the terminal which is marked with the letter L or coloured red.

IMPORTANT

A 5 or 13 ampere fuse is fitted in this plug. Should the fuse need to be replaced, please ensure that the replacement fuse has a rating of 5 or 13 amperes and that it is approved by ASTA or BSI to BS1362. Check for the ASTA mark or the BSI mark on the body of the fuse. **IF THE FITTED MOULDED PLUG IS UNSUITABLE FOR THE SOCKET OUTLET IN YOUR HOME THEN THE FUSE SHOULD BE REMOVED AND THE PLUG CUT OFF AND DISPOSED OF SAFELY. THERE IS A DANGER OF SEVERE ELECTRICAL SHOCK IF THE CUT OFF PLUG IS INSERTED INTO ANY 13 AMPERE SOCKET.**

If in any doubt, consult a qualified electrician.

For European Models

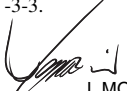
Declaration of Conformity	
<p>We, ONKYO EUROPE ELECTRONICS GmbH LIEGNITZERSTRASSE 6, 82194 GROEBENZELL, GERMANY</p>	
<p>declare in own responsibility, that the ONKYO product described in this instruction manual is in compliance with the corresponding technical standards such as EN60065, EN55013, EN55020 and EN61000-3-2, -3-3.</p>	
<p>GROEBENZELL, GERMANY</p>	 I. MORI
ONKYO EUROPE ELECTRONICS GmbH	

Precautions—Continued

For U.S. models

Note to CATV system installer:

This reminder is provided to call the CATV system installer's attention to Section 820-40 of the NEC which provides guidelines for proper grounding and, in particular, specifies that the cable ground shall be connected to the grounding system of the building, as close to the point of cable entry as practical.

FCC Information for User

CAUTION:

The user changes or modifications not expressly approved by the party responsible for compliance could void the user's authority to operate the equipment.

NOTE:

This equipment has been tested and found to comply with the limits for a Class B digital device, pursuant to Part 15 of the FCC Rules. These limits are designed to provide reasonable protection against harmful interference in a residential installation.

This equipment generates, uses and can radiate radio frequency energy and, if not installed and used in accordance with the instructions, may cause harmful interference to radio communications. However, there is no guarantee that interference will not occur in a particular installation. If this equipment does cause harmful interference to radio or television reception, which can be determined by turning the equipment off and on, the user is encouraged to try to correct the interference by one or more of the following measures:

- Reorient or relocate the receiving antenna.
- Increase the separation between the equipment and receiver.
- Connect the equipment into an outlet on a circuit different from that to which the receiver is connected.
- Consult the dealer or an experienced radio/TV technician for help.

Supplied Accessories

Make sure you have the following accessories:

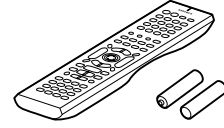

Remote controller & two batteries (AA/R6)

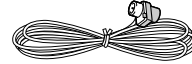

Indoor FM antenna

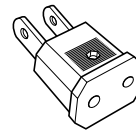

Power-plug adapter

Only supplied in certain countries. Use this adapter if your AC outlet does not match with the plug on the TX-L55's power cord. (Adapter varies from country to country.)

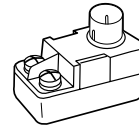

75/300-ohm antenna adapter

(Not supplied with American and European models.)

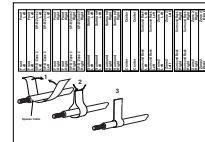

Speaker cable labels

* In catalogs and on packaging, the letter added to the end of the product name indicates the color of the TX-L55. Specifications and operation are the same regardless of color.

Features

- 60 W/Ch, Continuous 6 ohms, 1 kHz (FTC)
- Exclusive Onkyo Digital Amplifier Technology
- DTS-ES Discrete/Matrix 6.1, DTS NEO:6, DTS 96/24¹, Dolby Digital EX, Dolby Pro Logic IIx²
- Discrete Output Stage Circuitry
- Non-Scaling Configuration
- Optimum Gain Volume Control
- 5 DSP Modes
- 2 Component Inputs / 1 Output
- 3 Digital Inputs / Subwoofer Pre Out
- Color-Coded Multichannel Inputs for DVD-Audio and Super Audio CD
- CinemaFILTER³
- Double Bass
- Crossover Adjustment (60/80/100/120/150 Hz)
- Source Direct Mode
- Preprogrammed (for TV and DVD Players)

1. "DTS," "DTS 96/24," "DTS-ES," and "Neo:6" are trademarks of Digital Theater Systems, Inc.
2. Manufactured under license from Dolby Laboratories. "Dolby," "Pro Logic" and the double-D symbol are trademarks of Dolby Laboratories.
3. CinemaFILTER is a trademark of Onkyo Corporation.

Table of Contents

Important Safety Instructions	2	Basic Setup	30
Precautions	3	Speaker Setup.....	30
Supplied Accessories	4	Assigning Inputs to Input Sources	31
Features	5	Basic Operation	33
Before Using the TX-L55	7	Selecting the Input Source	33
Installing the Batteries.....	7	Setting the Display Brightness	34
Using the Remote Controller.....	7	Muting the TX-L55.....	34
Front & Rear Panels	8	Using the Sleep Timer.....	35
Front Panel	8	Using Headphones	35
Display	9	Listening to the Radio.....	36
Rear Panel	10	Displaying Radio Information	38
Remote Controller	11	Using the Listening Modes	39
AMP/TUNER Mode	11	Selecting Listening Modes	39
DVD Mode	12	About the Listening Modes.....	40
TV Mode	14	Input Signal Formats & Listening Modes.....	42
About Home Theater	15	Dolby Digital/DTS Setting (5.1- or 6.1-channel Playback)	43
Enjoying Home Theater	15	Advanced Operation	44
Connecting Speakers	16	Adjusting Speaker Levels	44
Connecting Speakers.....	16	Using the Late Night Function (Dolby Digital only)	44
Connecting Antenna	18	Using the CinemaFILTER	44
Connecting Antenna	18	Using the DVD Multichannel Input	45
Connecting AV Components	20	Displaying Source Information	46
Before Making Any Connections.....	20	Recording	47
AV Cables & Sockets	20	Advanced Setup	48
Connecting Both Audio & Video.....	21	Speaker Setup (Advanced)	48
Which Connections Should I Use?	21	Input Source Audio Setup	51
Connecting Your TV or Projector	22	Audio Adjust Functions.....	52
Connecting Your DVD player	23	Controlling Other Components	55
Connecting a VCR for Playback	24	Entering Remote Control Codes	55
Connecting a D-VHS VCR for Playback ...	25	Resetting the Remote Mode Buttons	58
Connecting a VCR for Recording.....	25	Resetting the Remote Controller	58
Connecting Other Video Sources —Set-top Box (Satellite, Cable, Over-the- Air), LD Player, etc.	26	Troubleshooting	59
Connecting a CD Player	27	Specifications	62
Connecting a CD, MiniDisc, DAT, or Cassette Recorder	27		
Connecting a Turntable.....	28		
Connecting an Onkyo DVD Player with RI	29		
Connecting the Power Cord.....	29		
Turning On the TX-L55	29		

Before Using the TX-L55

Installing the Batteries

- 1** To open the battery compartment, press the small hollow and slide off the cover.

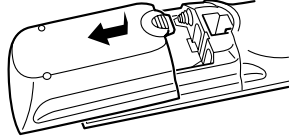

- 2** Insert the two supplied batteries (AA/R6) in accordance with the polarity diagram inside the battery compartment.

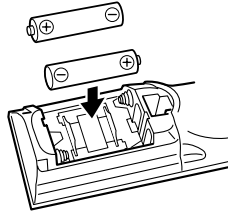

- 3** Put the cover onto the remote controller and slide it shut.

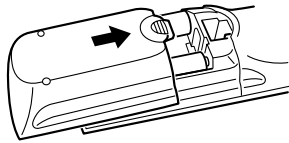

Notes:

- The batteries should last for about six months, although this will vary with usage.
- If the remote controller doesn't work reliably, try replacing the batteries.
- Don't mix new and old batteries or different types of batteries.
- If you intend not to use the remote controller for a long time, remove the batteries to prevent damage from leakage or corrosion.
- Expired batteries should be removed as soon as possible to prevent damage from leakage or corrosion.

Using the Remote Controller

To use the remote controller, point it at the TX-L55's remote control sensor, as shown below.

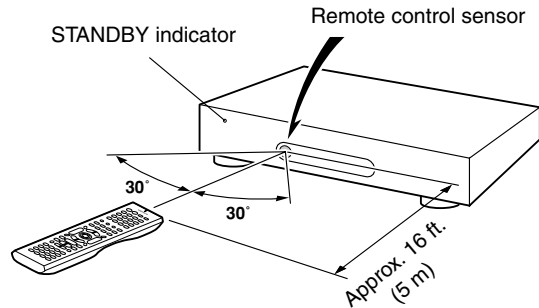

Notes:

- The remote controller may not work reliably if the TX-L55 is subjected to bright light, such as direct sunlight or inverter-type fluorescent lights. Keep this in mind when installing.
- If another remote controller of the same type is used in the same room, or the TX-L55 is installed close to equipment that uses infrared rays, the remote controller may not work reliably.
- Don't put anything, such as a book, on the remote controller, because the buttons may be pressed inadvertently, thereby draining the batteries.
- The remote controller may not work reliably if the TX-L55 is installed in a rack behind colored glass doors. Keep this in mind when installing.
- The remote controller will not work if there's an obstacle between it and the TX-L55's remote control sensor.

Front & Rear Panels

Front Panel

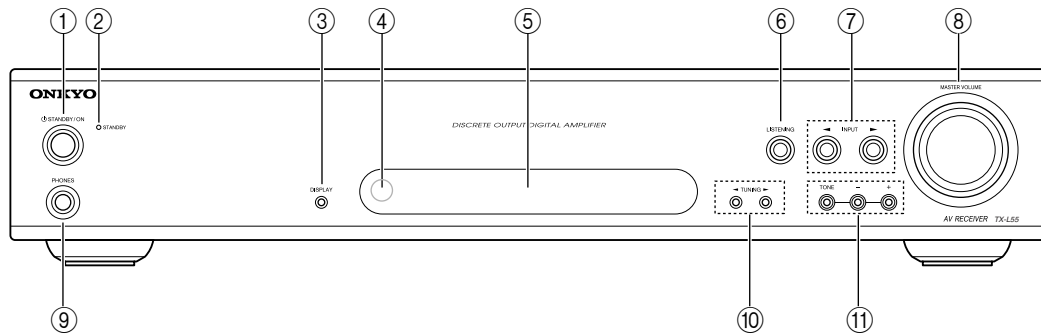

For detailed information, refer to the pages in parenthesis.

- ① **STANDBY/ON button (29)**
This button is used to set the TX-L55 to On or Standby.
- ② **STANDBY indicator (29)**
This indicator lights up when the TX-L55 is in Standby mode, and it flashes while a signal is being received from the remote controller.
- ③ **DISPLAY button (46)**
This button is used to display various information about the currently selected source.
- ④ **Remote control sensor (7)**
This sensor receives control signals from the remote controller.
- ⑤ **Display**
See "Display" on page 9 for more information.
- ⑥ **LISTENING button (39)**
This button is used to select the listening modes. It's illuminated while the TX-L55 is on.
- ⑦ **INPUT [◀]/[▶] buttons (33, 47)**
These buttons are used to select the input source. They're illuminated while the TX-L55 is on.
- ⑧ **MASTER VOLUME control (33)**
This control is used to set the volume of the TX-L55.
- ⑨ **PHONES jack (35)**
This 1/4-inch phone jack is for connecting a standard pair of stereo headphones for private listening.
- ⑩ **TUNING [◀]/[▶] buttons (36)**
These buttons are used to tune the radio.
- ⑪ **TONE, [-] & [+] buttons (52)**
These buttons are used to adjust the bass and treble.

Front & Rear Panels—Continued

Display

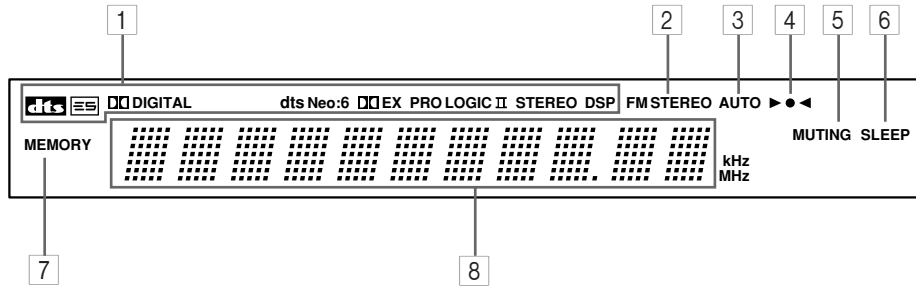

For detailed information, refer to the pages in parenthesis.

- 1 **Source/listening mode indicators (41)**
These indicators show the currently selected listening mode and digital audio format.
- 2 **FM STEREO indicator (36)**
This indicator lights up when the radio is tuned to a stereo FM station.
- 3 **AUTO indicator (36)**
This indicator lights up when the Auto Tuning mode is selected. Stereo FM stations can be enjoyed in this mode.
- 4 **Tuned ►●◄ indicator (36)**
This indicates the radio reception status.
- 5 **MUTING indicator (34)**
This indicator flashes when the TX-L55 is muted.
- 6 **SLEEP indicator (35)**
This indicator lights up when the Sleep function has been set.
- 7 **MEMORY indicator (37)**
This indicator flashes when presetting radio stations.
- 8 **Message area**
This area of the display shows various information about the currently selected source.

Front & Rear Panels—Continued

Rear Panel

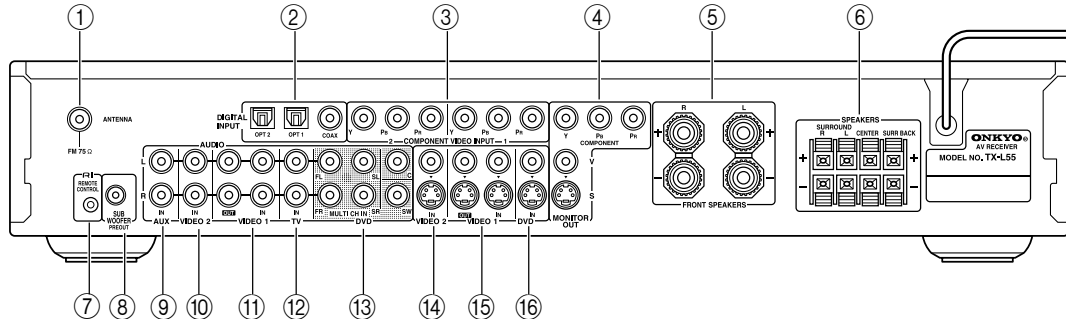

For detailed information, refer to the pages in parenthesis.

① **FM ANTENNA (18)**

This socket is for connecting an FM antenna.

② **DIGITAL INPUT OPT 1, OPT 2 & COAX (20–23, 25–28)**

These optical and coaxial digital audio inputs can be used to connect a DVD, CD, LD (laser disc) player or other components with digital audio outputs.

③ **COMPONENT VIDEO INPUT 1, 2 (20–23, 25, 26)**

These component video inputs can be used to connect AV components with component video outputs, such as DVD players and TVs. Component video connections provide better picture quality than S-Video. Use dedicated component video cables.

④ **MONITOR OUT (21, 22)**

These component video, S-Video, and composite video outputs can be connected to the video inputs on your TV or projector.

Only video signals from a video input of the same format are output. For example, the COMPONENT MONITOR OUT outputs component video signals received by COMPONENT VIDEO INPUT 1 or 2, not an S-Video or composite video input.

⑤ **FRONT SPEAKERS (16, 17)**

These terminal posts are for connecting front speakers.

⑥ **SPEAKERS (16, 17)**

These push terminals are for connecting surround left, surround right, center, and surround back speakers.

⑦ **RI REMOTE CONTROL (29)**

This **RI** (Remote Interactive) socket can be connected to the **RI** socket on another Onkyo component. The TX-L55's remote controller can then be used to control that component. To use **RI**, you must make an analog audio connection (RCA)

between the TX-L55 and the other component, even if they are connected digitally.

Note:

RI can only be used with Onkyo components.

⑧ **SUBWOOFER PRE OUT (17)**

A powered subwoofer can be connected here.

⑨ **AUX AUDIO IN (27, 28)**

An audio component such as a CD player can be connected here by using an RCA audio cable.

⑩ **VIDEO 2 AUDIO IN (25, 27)**

The audio output of a set-top box (cable, satellite, over-the-air) can be connected here by using an RCA audio cable.

⑪ **VIDEO 1 AUDIO IN/OUT (24, 25, 27)**

The audio input and output of a VCR or MD recorder can be connected here by using RCA audio cables.

⑫ **TV AUDIO IN (22)**

The audio output of a TV can be connected here by using an RCA audio cable.

⑬ **DVD MULTI CH IN (24)**

The stereo analog audio output or multichannel (5.1-channel) analog audio output of a DVD player can be connected here.

⑭ **VIDEO 2 IN (25, 26)**

The S-Video or composite video output of a set-top box (cable, satellite, over-the-air) can be connected here.

⑮ **VIDEO1 IN/OUT (24, 25)**

The S-Video or composite video input and output of a VCR can be connected here.

⑯ **DVD IN (23)**

The S-Video or composite video output of a DVD player can be connected here.

Remote Controller

AMP/TUNER Mode

AMP/TUNER mode is used to control the TX-L55.

To select AMP/TUNER mode, press the **REMOTE MODE [AMP]** button.

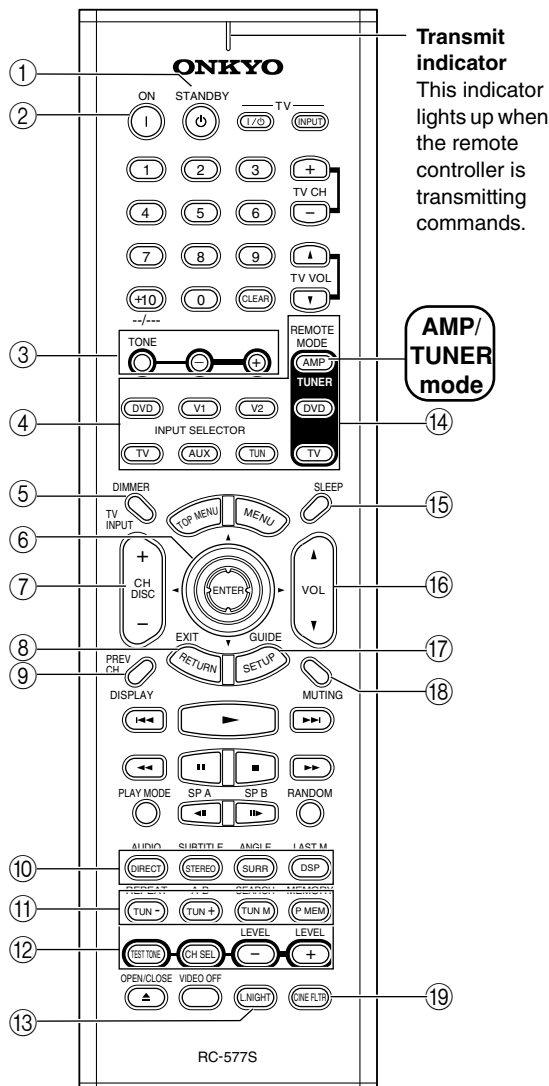

For detailed information, refer to the pages in parenthesis.

- ① **STANDBY button (29)**
This button is used to set the TX-L55 to Standby.
- ② **ON button (29)**
This button is used to turn on the TX-L55.
- ③ **TONE, [-] & [+] buttons (52)**
These buttons are used to adjust the bass and treble.

- ④ **INPUT SELECTOR buttons (31–33)**
These buttons are used to select the input source.
- ⑤ **DIMMER button (34)**
This button is used to adjust the display brightness.
- ⑥ **Arrow [▲]/[▼]/[◀]/[▶] & ENTER button**
This button is used to select and adjust settings.
- ⑦ **CH +/- button (37)**
This button is used to select radio presets.
- ⑧ **RETURN button**
This button is used to return to the previous screen when changing settings.
- ⑨ **DISPLAY button (38, 46)**
This button is used to display various information about the currently selected input source.
- ⑩ **Listening mode buttons (39)**
DIRECT button
This button is used to select the Direct listening mode.
STEREO button
This button is used to select the Stereo listening mode.
SURR button
This button is used to select the Dolby and DTS listening modes.
DSP button
This button is used to select the Onkyo original DSP (digital signal processor) listening modes.
- ⑪ **TUN-, TUN+, TUN M & P MEM buttons (36, 37)**
These buttons are used with the tuner.
- ⑫ **TEST TONE, CH SEL, LEVEL- & LEVEL+ buttons (30, 31, 44)**
These buttons are used to adjust the level of each speaker individually.
- ⑬ **L.NIGHT button (44)**
This button is used to set the Late Night function.
- ⑭ **REMOTE MODE buttons**
These buttons are used to select the remote controller modes. When you use the remote controller, the mode button for the currently selected mode lights up.
- ⑮ **SLEEP button (35)**
This button is used to set the Sleep function.
- ⑯ **VOL ▲/▼ button (33)**
This button is used to set the volume of the TX-L55.
- ⑰ **SETUP button**
This button is used to access various settings.
- ⑱ **MUTING button (34)**
This button is used to mute the TX-L55.
- ⑲ **CINE FLTR button (44)**
This button is used to set the CinemaFILTER function.

Remote Controller—Continued

DVD Mode

DVD mode can be used to control an Onkyo DVD player connected to the TX-L55 via **RI**. It can also be used to control other DVD players (see page 55).

To select DVD mode, press the **REMOTE MODE [AMP]** button followed by the **[DVD] INPUT SELECTOR** button to select your DVD player as the input source.

Before selecting DVD mode and starting playback, press the **REMOTE MODE [AMP]** button followed by the **[DVD] INPUT SELECTOR** button to select your DVD player as the input source.

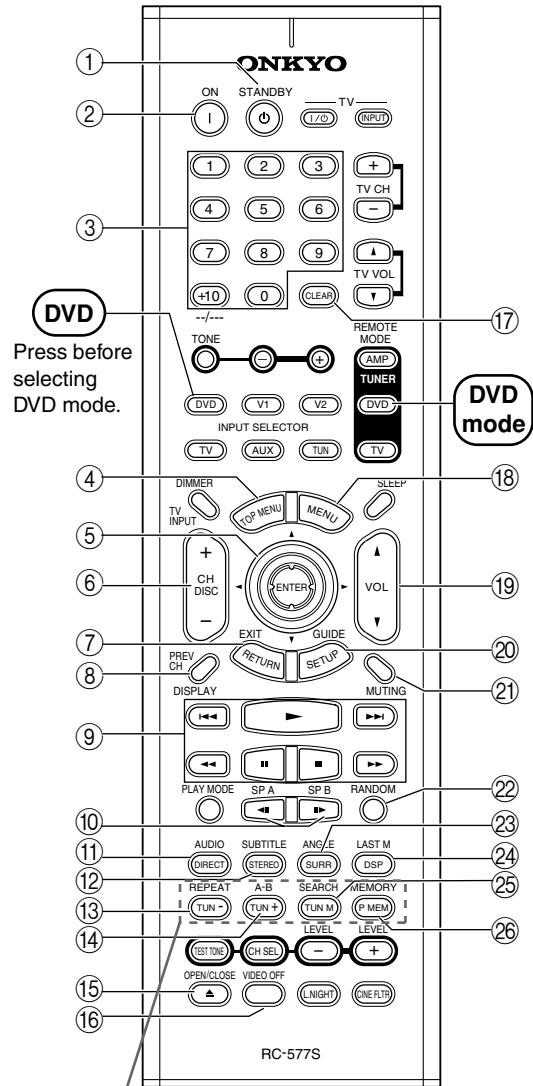

Note:

Depending on your DVD player, pressing this button may display an onscreen play mode menu.

Remote Controller—Continued

- ① **STANDBY button**
This button is used to set the DVD player to Standby.
- ② **ON button**
This button is used to turn on the DVD player and set it to Standby.
- ③ **Number buttons**
These buttons are used to enter title, chapter, and track numbers and times for locating specific points in time.
- ④ **TOP MENU button**
This button is used to select a DVD's top menu.
- ⑤ **Arrow [▲]/[▼]/[◀]/[▶] & ENTER button**
This button is used to navigate DVD menus and the DVD player's onscreen setup menus.
- ⑥ **DISC +/- button**
This button selects discs on a DVD changer.
- ⑦ **RETURN/EXIT button**
This button is used to return to the DVD player's previously displayed onscreen setup menu, and to exit the onscreen setup menus.
- ⑧ **DISPLAY button**
This button is used to display information about the current disc, title, chapter, or track on the DVD player's display, including the elapsed time, remaining time, total time, and so on.
- ⑨ **Playback buttons**
From left to right: Previous, Play, Next, Fast Reverse, Pause, Stop, and Fast Forward. They can also be used in AMP mode.
- ⑩ **Step & Slow [◀||]/[||▶] buttons**
These buttons are used for frame-by-frame playback and slow-motion playback. They can also be used in AMP mode.
- ⑪ **AUDIO button**
This button is used to select foreign language soundtracks and audio formats (e.g., Dolby Digital or DTS).
- ⑫ **SUBTITLE button**
This button is used to select subtitles.
- ⑬ **REPEAT button**
This button is used to set the repeat playback functions. Depending on your DVD player, pressing this button may display an onscreen play mode menu.
- ⑭ **A-B button**
This button is used to set the A–B repeat playback function. Depending on your DVD player, pressing this button may display an onscreen play mode menu.
- ⑮ **OPEN/CLOSE [▲] button**
This button is used to open and close the disc tray.
- ⑯ **VIDEO OFF button**
This button is used to turn off the internal video circuitry, eliminating the possibility of interference when playing audio-only discs.
- ⑰ **CLEAR button**
This button is used to cancel functions and to clear entered numbers.
- ⑱ **MENU button**
This button is used to display a DVD's menu.
- ⑲ **VOL ▲/▼ button**
This button sets the volume of the TX-L55.
- ⑳ **SETUP/GUIDE button**
This button is used to access the DVD player's onscreen setup menus.
- ㉑ **MUTING button**
This button mutes the TX-L55.
- ㉒ **RANDOM button**
This button is used with the random playback function.
- ㉓ **ANGLE button**
This button is used to select different camera angles.
- ㉔ **LAST M button**
This button is used with the last memory function, which allows you to resume DVD playback from where you left off.
- ㉕ **SEARCH button**
This button is used to search for titles, chapters, tracks, and specific points in time. Depending on your DVD player, pressing this button may display an onscreen play mode menu.
- ㉖ **MEMORY button**
This button is used with the memory playback function, which allows you to create a custom playlist of titles, chapters, and tracks. Depending on your DVD player, pressing this button may display an onscreen play mode menu.

Remote Controller—Continued

TV Mode

TV mode can be used to control your TV. You must enter the appropriate remote control code for your TV before using this mode (see page 55).

To select TV mode, press the **REMOTE MODE [TV] button**.

To listen to the sound from your TV through the TX-L55, before selecting TV mode, press the **REMOTE MODE [AMP] button** followed by the **[TV] INPUT SELECTOR button** to select your TV as the input source.

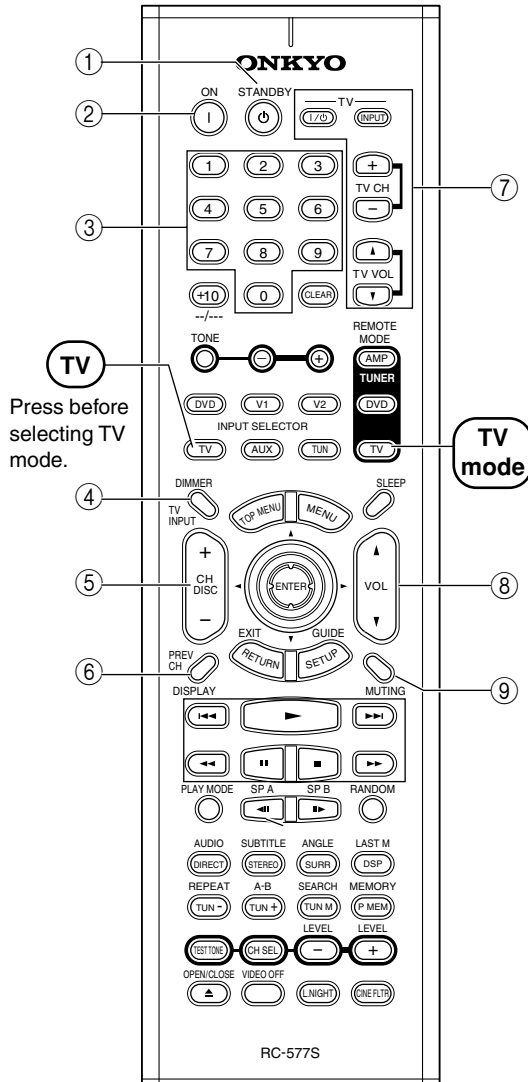

① **STANDBY button**

This button is used to set the TV to Standby.

② **ON button**

This button is used to turn on the TV.

③ **Number buttons**

These buttons are used to enter TV channel numbers.

④ **TV INPUT button**

This button is used to select the TV's AV inputs.

⑤ **CH +/- button**

This button is used to select channels on the TV.

⑥ **PREV CH button**

This button is used to select the previously selected channel on the TV.

⑦ **TV buttons**

These buttons control the TV regardless of which remote controller mode is selected.

TV \square /| button

This button is used to turn on the TV and to set it to Standby.

TV INPUT button

This button is used to select the TV's AV inputs. It works the same as button ④.

TV CH +/- buttons

These buttons are used to select channels on the TV. They work the same as button ⑤.

TV VOL buttons

These buttons are used to adjust the TV's volume. They work the same as button ⑧.

⑧ **VOL \blacktriangle / \blacktriangledown button**

This button is used to adjust the TV's volume.

⑨ **MUTING button**

This button mutes the TV's volume.

About Home Theater

Enjoying Home Theater

With the TX-L55's superb functionality you can enjoy surround sound with a real sense of movement in your own home—just like being in a movie theater or concert hall.

For best results with DVDs that feature THX Surround EX, use a THX-certified THX speaker system.

With DVDs you can enjoy DTS, Dolby Digital, and THX soundtracks. With TV and satellite broadcasts you can enjoy Onkyo's original DSP surround listening modes.

Front left and right speakers

These output the overall sound. Their role in a home theater is to provide a solid anchor for the sound image. They should be positioned facing the listener at about ear level, and equidistant from the TV. Angle them inward so as to create a triangle, with the listener at the apex.

Center speaker

This speaker enhances the front left and right speakers, making sound movements distinct and providing a full sound image. In movies it's used mainly for dialog. Position it close to your TV (preferably on top) facing forward at about ear level, or at the same height as the front left and right speakers.

Subwoofer

The subwoofer handles the bass sounds of the LFE (Low-Frequency Effects) channel. The volume and quality of the bass output from your subwoofer will depend on its position, the shape of your listening room, and your listening position. In general, a good bass sound can be obtained by installing the subwoofer in a front corner, or at one-third the width of the wall, as shown.

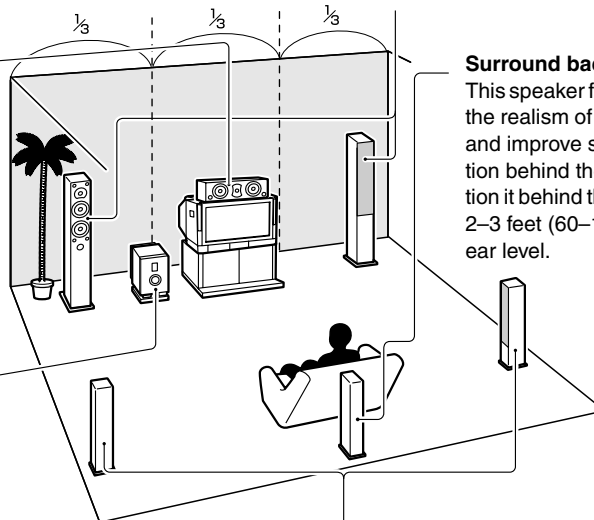

Surround back speaker

This speaker further enhances the realism of surround sound and improves sound localization behind the listener. Position it behind the listener about 2–3 feet (60–100 cm) above ear level.

Surround left and right speakers

These speakers are used for precise sound positioning and to add realistic ambience. Position them at the sides of the listener, or slightly behind, about 3 feet (100 cm) above ear level. Ideally they should be equidistant from the listener.

Speaker Configuration

For the best surround-sound experience, you should connect six speakers and a powered subwoofer.

The following table shows which channels you should use depending on the number of speakers that you have.

Number of speakers:	2	3	4	5	6
Front left	✓	✓	✓	✓	✓
Front right	✓	✓	✓	✓	✓
Center		✓		✓	✓
Surround left			✓	✓	✓
Surround right			✓	✓	✓
Surround back					✓

No matter how many speakers you use, a powered subwoofer is recommended for a really powerful and solid bass sound.

To get the best from your surround-sound system, as a bare minimum you need to do the Speaker Setup (see "Speaker Setup" on page 30). This consists of automatically detecting which speakers are connected and adjusting the volume level of each speaker. For a more detailed setup, you should specify which speakers are connected and their sizes (see page 48), adjust the subwoofer crossover frequency (see page 49), specify the distance from each speaker to the listening position (see page 50), and then adjust the volume level of each speaker (see "Speaker Level Calibration (Test Tone)" on page 30).

Connecting Speakers

Connecting Speakers

Before you connect your speakers, read the following:

- Disconnect the power cord from the wall outlet.
- Read the instructions supplied with your speakers.
- Pay close attention to speaker wiring polarity. In other words, connect positive (+) terminals only to positive (+) terminals, and negative (-) terminals only to negative (-) terminals. If you get them the wrong way around, the sound will be out of phase and will sound odd.
- Only use speakers with an impedance of between 6 and 16 ohms. If you use speakers with a lower impedance, and use the amplifier at high volume levels for a long period of time, the built-in protection circuit may be activated.
- Unnecessarily long or very thin speaker cables may affect the sound quality and should be avoided.
- Be careful not to short the positive and negative connections. Doing so may damage the TX-L55.
- Don't connect more than one cable to each speaker terminal. Doing so may damage the TX-L55.
- If you want to connect a single speaker instead of a pair, connect it to either the left or right speaker terminals, not both.

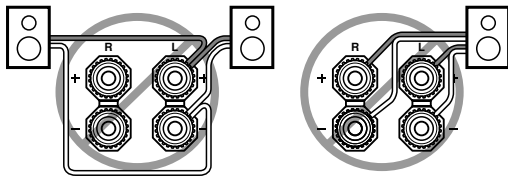
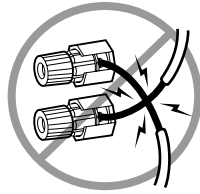

Attaching the Speaker Labels

The TX-L55's positive (+) speaker terminals are color-coded for ease of identification. (The negative (-) speaker terminals are all black.)

Speaker terminal	Color
Front left	White
Front right	Red
Center	Green
Surround left	Blue
Surround right	Gray
Surround back	Brown

The supplied speaker labels are also color-coded and you should attach them to the positive (+) side of each speaker cable in accordance with the above table.



Connecting the Front Speaker Cables

- 1 Strip 5/8" (15 mm) of insulation from the ends of the speaker cables, and twist the bare wires tightly, as shown.

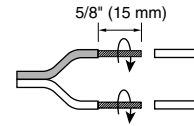

- 2 Unscrew the terminal. Fully insert the bare wires. Screw the terminal tight.

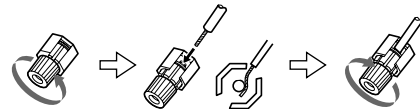

Connecting the Other Speaker Cables

- 1 Strip 3/8" (10 mm) of insulation from the ends of the speaker cables, and twist the bare wires tightly.

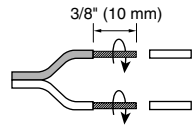

- 2 While pushing the lever, insert the wire into the hole, and then release the lever.

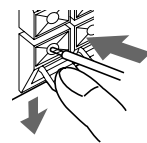

Maker sure that the speaker connectors are gripping the bare wires, not the insulation.

Connecting Speakers—Continued

The following illustration shows which speakers should be connected to which terminals.

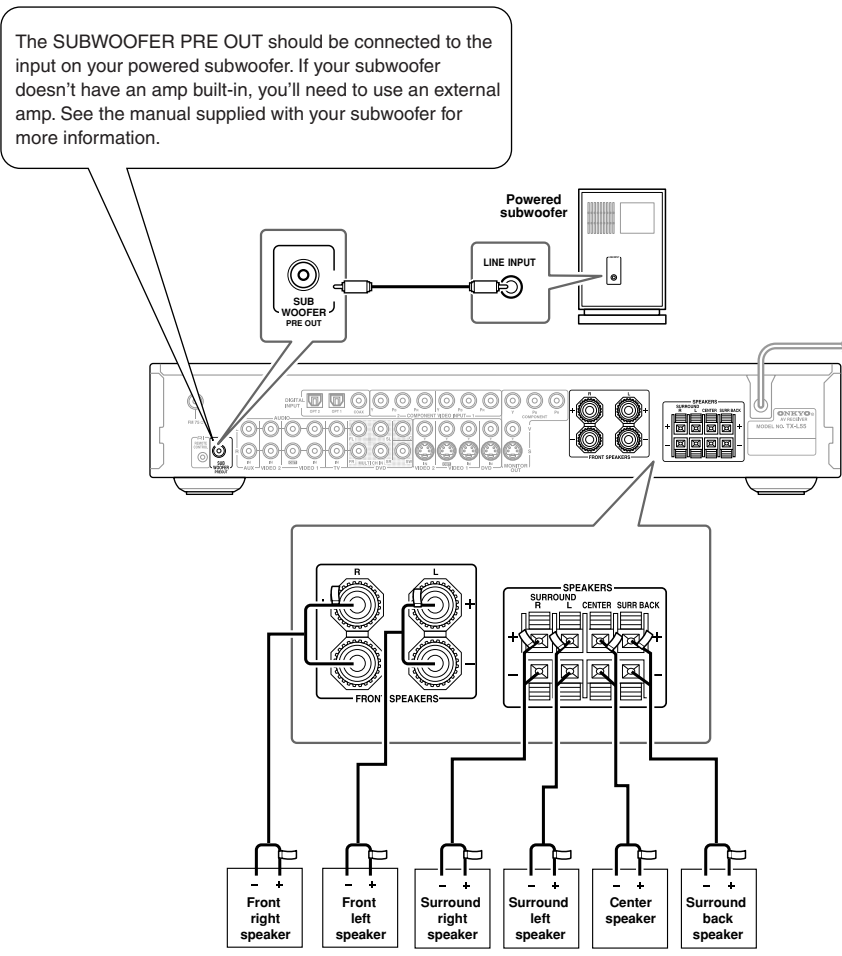

Connecting Antenna

Connecting Antenna

This chapter explains how to connect the supplied indoor FM antenna and how to connect commercially available outdoor FM antenna.

The TX-L55 won't pick up any radio signals without any antenna connected, so you must connect the antenna to use the tuner.

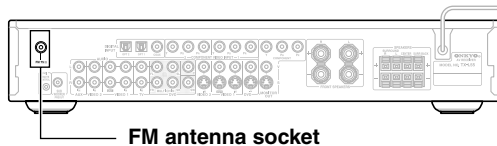

Connecting the Indoor FM Antenna

The supplied indoor FM antenna is for indoor use only.

1 Attach the FM antenna, as shown.

■ American Model

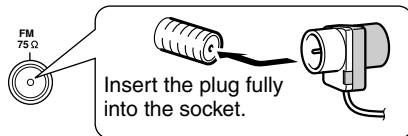

■ Other Models

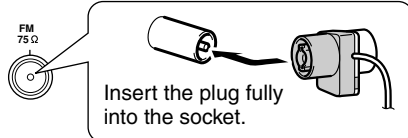

Once the TX-L55 is ready for use, you'll need to tune into an FM radio station and adjust the position of the FM antenna to achieve the best possible reception.

2 Use thumbtacks or something similar to fix the FM antenna into position.

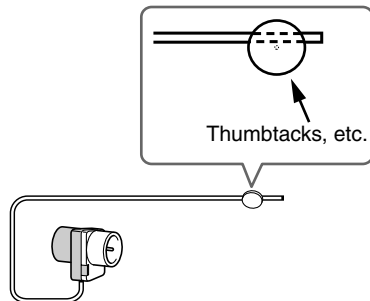

Caution: Be careful that you don't injure yourself when using thumbtacks.

Connecting an Outdoor FM Antenna

If you cannot achieve good reception with the supplied indoor FM antenna, try a commercially available outdoor FM antenna instead.

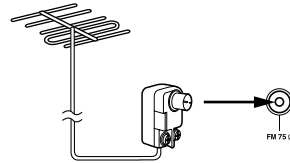

Notes:

- Outdoor FM antennas work best outside, but usable results can sometimes be obtained when installed in an attic or loft.
- For best results, install the outdoor FM antenna well away from tall buildings, preferably with a clear line of sight to the transmitter.
- Outdoor antenna should be located away from possible noise sources, such as neon signs, busy roads, etc.
- For safety reasons, outdoor antenna should be situated well away from power lines and other high-voltage equipment.
- Outdoor antenna must be grounded in accordance with local regulations to prevent electrical shock hazards.

Connecting Antenna—Continued

■ Using the 75/300-ohm Antenna Adapter

The 75/300-ohm Antenna Adapter is not supplied with American and European models.

The 75/300-ohm antenna adapter can be used to connect an FM antenna using either 75-ohm coaxial cable or 300-ohm twin-core flat cable.

■ Connecting 300-ohm Flat Cable

- Using a screwdriver, loosen the two screws on the adapter, wrap the bare wires around the screws, and then retighten them, as shown.

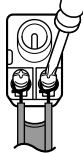

- Plug the adapter into the 75 Ω socket.

■ Using a TV/FM Antenna Splitter

It's best not to use the same antenna for both FM and TV reception, as this can cause interference problems. If circumstances demand it, use a TV/FM antenna splitter, as shown.

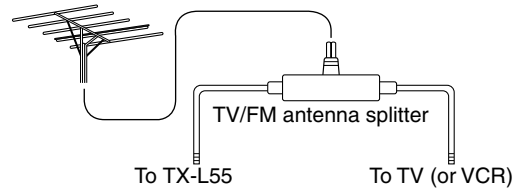

■ Connecting 75-ohm Coaxial Cable

- Strip and prepare the 75 ohm coaxial cable, as shown.

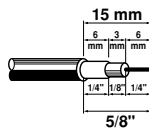

- Using your fingernails or a small screwdriver, lever the adapter's tabs outward and remove the cover, as shown.

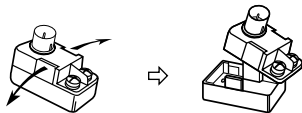

- Move the small wire inside the adapter from position A to position B, as shown.

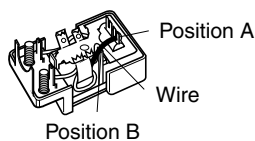

- Insert the central conductor (①), as shown, and use a small pair of pliers to clamp the shielding and outer insulation sections of the cable (②), as shown.

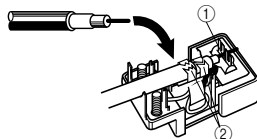

Make sure the shielding is not touching the central conductor.

- Refit the adapter's cover, and then plug the adapter into the 75 Ω socket.

Connecting AV Components

Before Making Any Connections

- Read the manuals supplied with your AV components.
- Don't connect the power cord until you've completed and double-checked all audio and video connections.

Optical Digital Inputs

The TX-L55's optical digital inputs have shutter-type covers that open when an optical plug is inserted and close when it's removed. Push plugs in all the way.

Caution: To prevent shutter damage, hold the optical plug straight when inserting and removing.

RCA AV Connection Color Coding

RCA-type AV connections are usually color coded: red, white, and yellow. Use red plugs to connect right-channel audio inputs and outputs (typically labeled "R"). Use white plugs to connect left-channel audio inputs and outputs (typically labeled "L"). And use yellow plugs to connect composite video inputs and outputs.



- Push plugs in all the way to make good connections (loose connections can cause noise or malfunctions).
- To prevent interference, keep audio and video cables away from power cords and speaker cables.

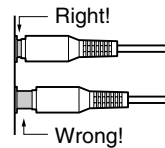

AV Cables & Sockets

Video

Cable	Socket	Description
		Component video separates the luminance (Y) and color difference signals (PR, PB), providing the best picture quality. (Some TV manufacturers label their component video sockets slightly differently.)
		S-Video separates the luminance and color signals and provides better picture quality than composite video.
		Composite video is commonly used on TVs, VCRs, and other video equipment. Use only dedicated composite video cables.

Audio

Cable	Socket	Description
		Offers the best sound quality and allows you to enjoy surround sound (e.g., Dolby Digital, DTS). The audio quality is the same as for coaxial.
		Offers the best sound quality and allows you to enjoy surround sound (e.g., Dolby Digital, DTS). The audio quality is the same as for optical.
		This cable carries analog audio. It's the most common connection format for analog audio, and can be found on virtually all AV components.
		This cable carries multichannel analog audio and it's typically used to connect DVD players with individual 5.1-channel analog audio outputs. Several standard analog audio cables can be used instead of a multichannel cable.

Connecting AV Components—Continued

Connecting Both Audio & Video

By connecting the audio and video outputs of your DVD player and other video components to the TX-L55, you can select both the audio and video source simultaneously simply by selecting the appropriate input source on the TX-L55.

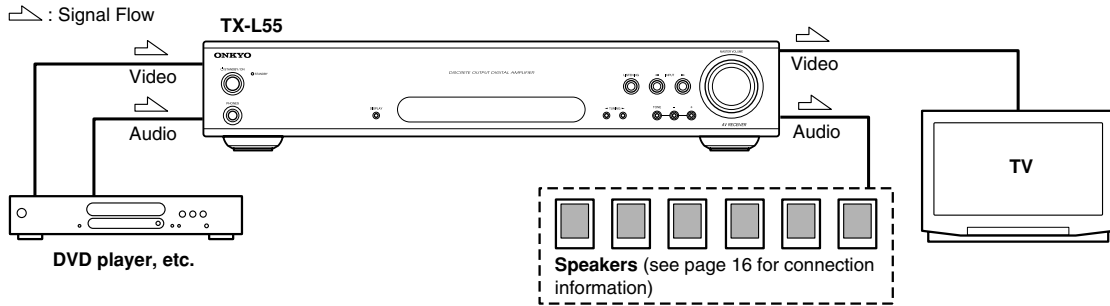

Which Connections Should I Use?

The TX-L55 supports several connection formats for compatibility with a wide range of AV equipment. The format you choose will depend on the formats supported by your other components. Use the following sections as a guide.

For video components, you must make two connections—one for the audio, one for the video.

Video Connection Formats

Video equipment can be connected to the TX-L55 by using one of the following video connection formats: composite video, S-Video, or component video, the latter offering the best picture quality.

When choosing a connection format, bear in mind that the TX-L55 doesn't convert between formats, so only outputs of the same format as the input will output the signal.

For example, if you connect your DVD player to the S DVD IN, a video signal will be output by the S MONITOR OUT (for your TV), but not by any composite video or component video outputs.

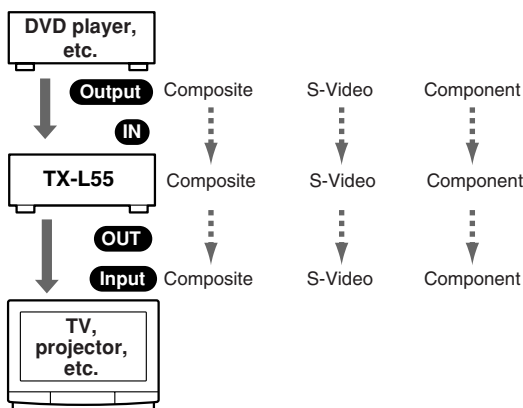

Audio Connection Formats

Audio equipment can be connected to the TX-L55 using the following audio connection formats: analog, optical, coaxial, and multichannel.

When choosing a connection format, bear in mind that the TX-L55 doesn't convert between formats.

For example, audio signals connected to an OPT or COAX digital input are not output by the analog VIDEO 1 AUDIO OUT, so if you want to record from, for example, your CD player, in addition to connecting it to a digital input, you must also connect it to the analog AUX IN.

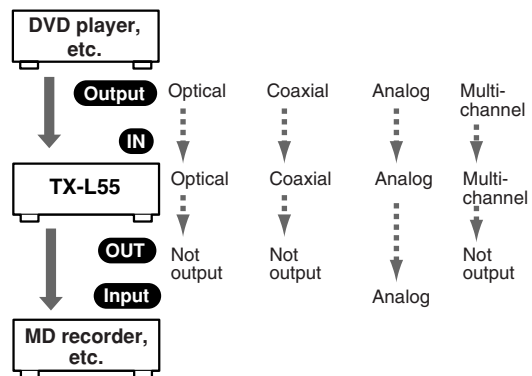

Connecting AV Components—Continued

Connecting Your TV or Projector

Monitor Out

■ Using Composite Video

Use a composite video cable to connect the TX-L55's V MONITOR OUT to a composite video input on your TV, as shown.

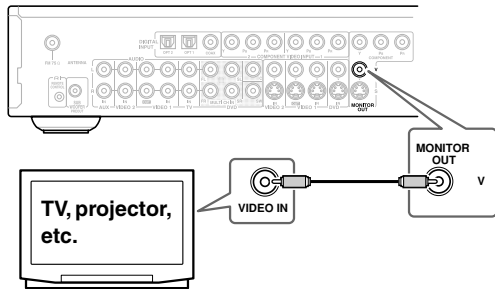

■ Using S-Video

Use an S-Video cable to connect the TX-L55's S MONITOR OUT to an S-Video input on your TV, as shown.

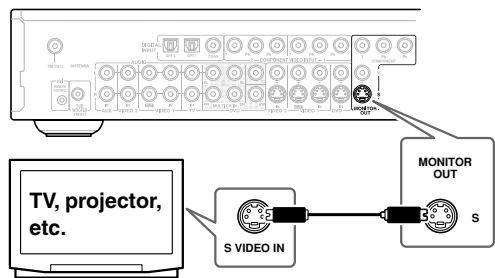

■ Using Component Video

Use a component video cable to connect the TX-L55's COMPONENT MONITOR OUT to a component video input on your TV, as shown.

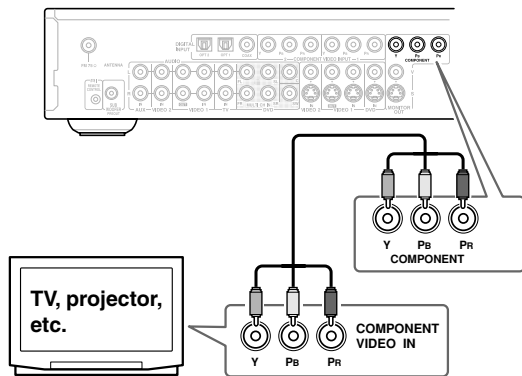

Audio Connections

These connections will allow you to listen to audio from your TV via the TX-L55.

If your TV has no audio outputs, connect the TX-L55 to your VCR and use its tuner (see page 24).

Note:

- Initially, the OPT 1 digital input is assigned to the TV input source. If you connect to a different digital audio input or only to an analog input, you'll need to assign it to the TV input source (see page 31).

■ Using a Coaxial or Optical Connection

- Use an optical digital audio cable to connect the TX-L55's OPT 1 DIGITAL INPUT to the optical output on your TV, as shown.

OR

- Use a coaxial digital audio cable to connect the TX-L55's COAX DIGITAL INPUT to the coaxial output on your TV, as shown.

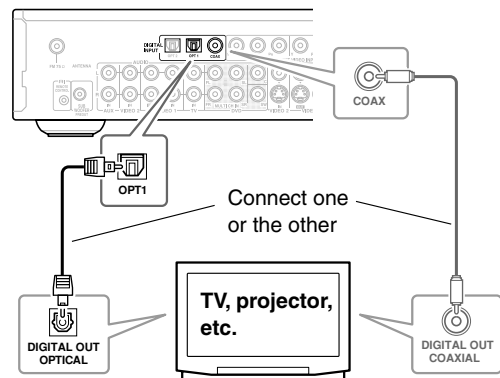

■ Using Analog Connections

If your TV doesn't have digital audio outputs, or you want to record from it, you'll need to make the following analog audio connections.

Use an analog audio cable to connect the TX-L55's TV IN L/R inputs to the analog audio outputs on your TV, as shown.

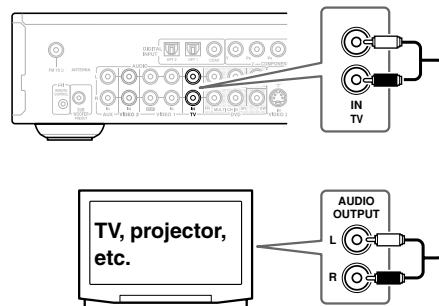

Connecting AV Components—Continued

Connecting Your DVD player

Video Connections

You only need to use one of the following video connection methods.

■ Using Composite Video

Use a composite video cable to connect the TX-L55's V DVD IN to the composite video output on your DVD player, as shown.

- Your TV must also be connected via composite video.

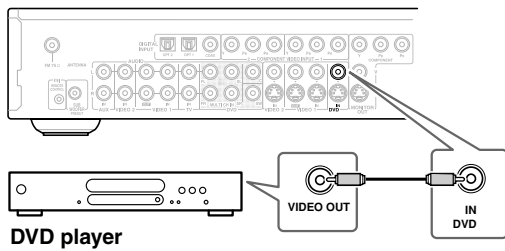

■ Using S-Video

Use an S-Video cable to connect the TX-L55's S DVD IN to the S-Video output on your DVD player, as shown.

- Your TV must also be connected via S-Video.

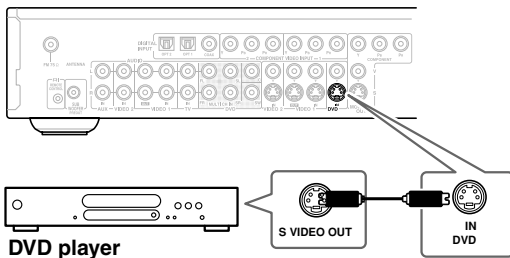

■ Using Component Video

Use a component video cable to connect the TX-L55's COMPONENT VIDEO INPUT 1 to the component video output on your DVD player, as shown.

- Your TV must also be connected via component video.

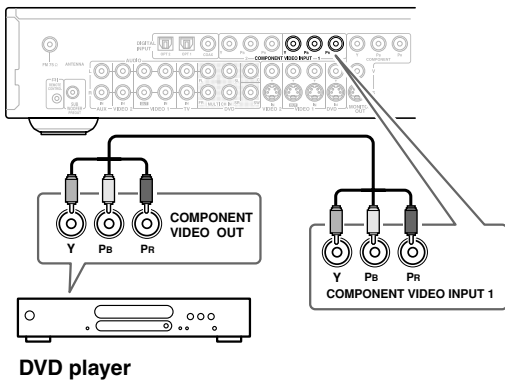

Audio Connections

Note:

- Initially, the COAX digital input is assigned to the DVD input source. If you connect your DVD player to a different digital input or only to an analog input, you'll need to assign it to the DVD input source (see page 31).

■ Using a Coaxial or Optical Connection

- Use a coaxial digital audio cable to connect the TX-L55's COAX DIGITAL INPUT to the coaxial output on your DVD player, as shown.

OR

- Use an optical digital audio cable to connect the TX-L55's OPT 1 DIGITAL INPUT to the optical output on your DVD player, as shown.

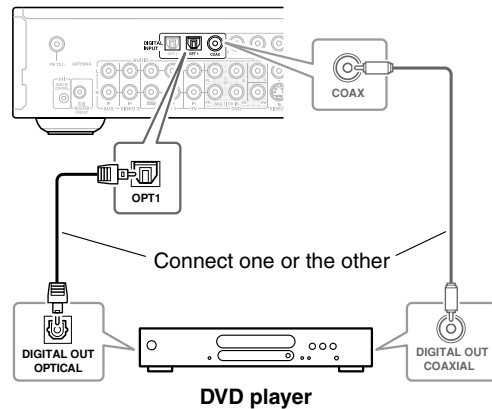

■ Using Analog Connections

Even if your DVD player is connected digitally (coaxial or optical), to use **RI**, or to record from it, you'll need to make analog connections as well.

Use an analog audio cable to connect the TX-L55's DVD MULTI CH IN FL/FR to the analog audio outputs on your DVD player, as shown.

If your DVD player has a multichannel output, be sure to use the left and right outputs.

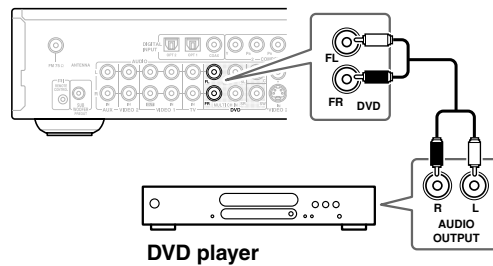

Connecting AV Components—Continued

DVD Multichannel Connection

If your DVD player supports multichannel audio formats such as SACD and DVD-Audio, and it has a multichannel analog audio output, you can enjoy those formats.

Use a multichannel analog audio cable to connect the TX-L55's DVD MULTI CH IN FR, FL, SL, SR, C, and SW sockets to the multichannel analog audio output on your DVD player, as shown. Alternatively, use three standard analog audio cables.

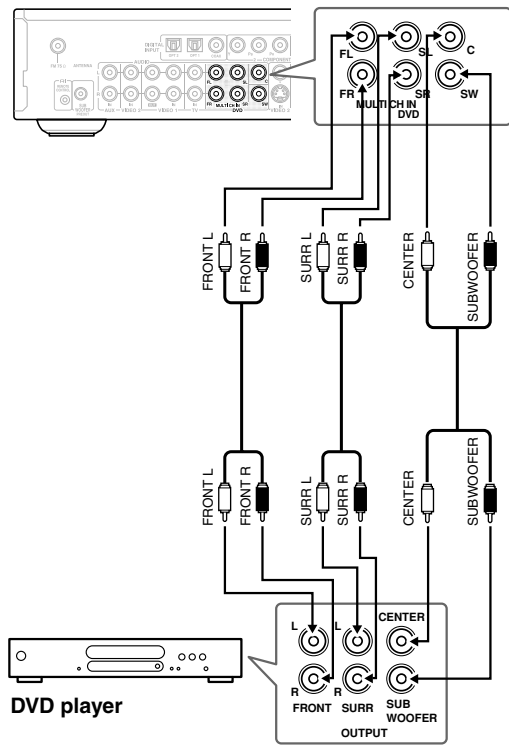

Note:

- If your DVD player has 5.1-channel, and 2-channel analog audio output sockets, and you intend to connect it to only the TX-L55's DVD MULTI CH IN FL/RL sockets, use the DVD player's 2-channel analog audio output sockets.

Connecting a VCR for Playback

You can watch videos by connecting your VCR to the TX-L55.

By using your VCR's tuner, this hookup example will allow you to enjoy the sound from your favorite TV programs through the TX-L55. This is useful if your TV has no audio outputs.

Video Connections

- Use an S-Video cable to connect the TX-L55's S VIDEO 1 IN to the S-Video output on your VCR, as shown.

OR

- Use a composite video cable to connect the TX-L55's V VIDEO 1 IN to a composite video output on your VCR, as shown.

An S-Video connection provides better picture quality than a composite video connection.

Audio Connections

- Use an analog audio cable to connect the TX-L55's VIDEO 1 IN L/R inputs to the analog audio outputs on your VCR, as shown.

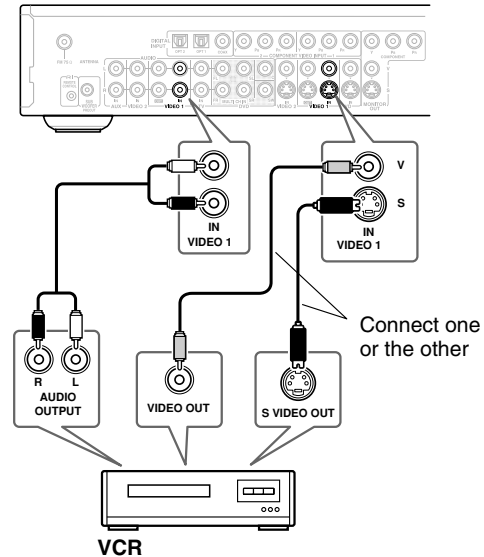

Connecting AV Components—Continued

Connecting a D-VHS VCR for Playback

Video Connections

Use a component video cable to connect the TX-L55's COMPONENT VIDEO 2 IN to the component video output on your D-VHS VCR, as shown.

Your TV must also be connected via component video. A component video connection provides better picture quality than an S-Video connection.

Audio Connections

- Use an optical digital audio cable to connect the TX-L55's OPT 2 DIGITAL INPUT to the optical output on your D-VHS VCR, as shown.

OR

- Use a coaxial digital audio cable to connect the TX-L55's COAX DIGITAL INPUT to the coaxial output on your D-VHS VCR, as shown.

You might need to change the digital input assignments (see page 31).

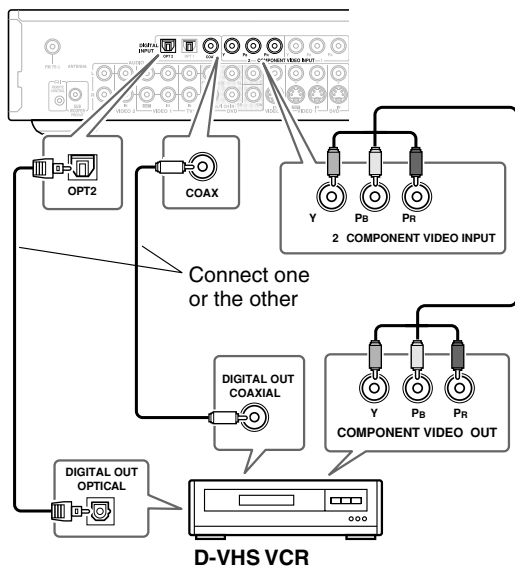

Connecting a VCR for Recording

Video Connections

- Use an S-Video cable to connect the TX-L55's S VIDEO 1 OUT to an S-Video input on your recording VCR.

OR

- Use a composite video cable to connect the TX-L55's V VIDEO 1 OUT to a composite video input on your recording VCR.

Audio Connections

- Use an analog audio cable to connect the TX-L55's AUDIO VIDEO 1 L/R OUTs to the audio inputs on your recording VCR.

This illustration shows how to connect a VCR for recording from a TV or another VCR.

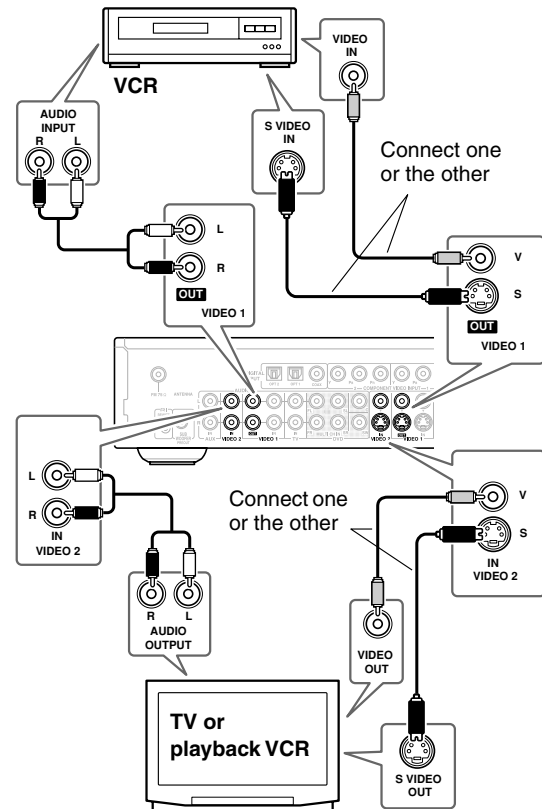

Notes:

- The TX-L55 must be turned on for recording. Recording is not possible while it's in Standby mode.
- If you want to record directly from your TV or playback VCR without going through the TX-L55, connect your TV/VCR's audio and video outputs directly to your recording VCR's AV inputs. See the manuals supplied with your TV and VCR for details.
- Video signals connected to composite video inputs can only be recorded via composite video outputs. If your TV and video playback components are connected via composite video, you must connect your recording VCR via composite video as well. Similarly, video signals connected to S-Video inputs can only be recorded via S-Video outputs. If your TV and video playback components are connected via S-Video, you must connect your recording VCR via S-Video as well.

Connecting AV Components—Continued

Connecting Other Video Sources—Set-top Box (Satellite, Cable, Over-the-Air), LD Player, etc.

Video Connections

You only need to use one of the following video connection methods.

■ Using Composite Video

Use a composite video cable to connect the TX-L55's V VIDEO 2 IN to the composite video output on your video component, as shown.

- Your TV must also be connected via composite video.

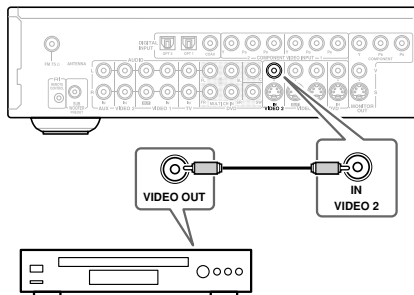

Set-top box (satellite, cable, over-the-air), LD player, etc.

■ Using S-Video

Use an S-Video cable to connect the TX-L55's S VIDEO 2 IN to the S-Video output on your video component, as shown.

- Your TV must also be connected via S-Video.

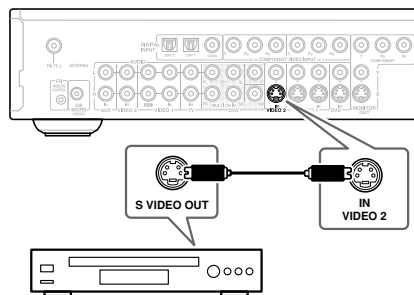

Set-top box (satellite, cable, over-the-air), LD player, etc.

■ Using Component Video

Use a component video cable to connect the TX-L55's COMPONENT VIDEO INPUT 2 to the component video output on your video component, as shown.

- Your TV must also be connected via component video.

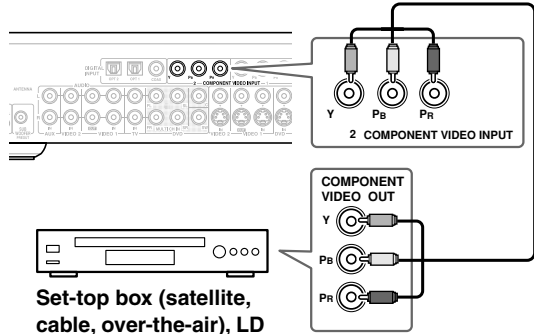

Set-top box (satellite, cable, over-the-air), LD player, etc.

Audio Connections

Notes:

- To connect an LD player with an AC-3RF output, you'll need a commercially available demodulator.

■ Using a Coaxial or Optical Connection

- Use an optical digital audio cable to connect the TX-L55's OPT 2 DIGITAL INPUT to the optical output on your video component, as shown.

OR

- Use a coaxial digital audio cable to connect the TX-L55's COAX DIGITAL INPUT to the coaxial output on your video component, as shown.
- Initially, the VIDEO 2 input source is not assigned to any of the digital audio inputs. If you use a digital input, you'll need to change the VIDEO 2 input source assignment (see page 31).

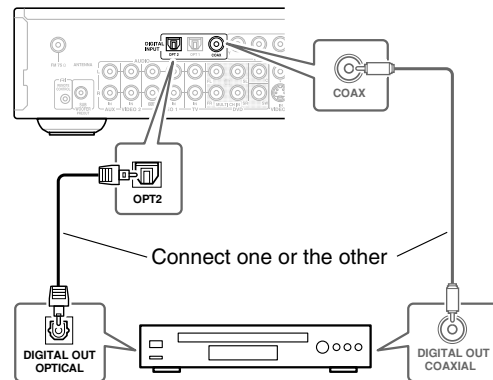

Set-top box (satellite, cable, over-the-air), LD player, etc.

Connecting AV Components—Continued

■ Using Analog Connections

If your video component doesn't have digital audio outputs, or you want to record from it, you'll need to make the following analog audio connections.

Use an analog audio cable to connect the TX-L55's AUDIO VIDEO 2 IN L/R inputs to the analog audio outputs on your video component, as shown.

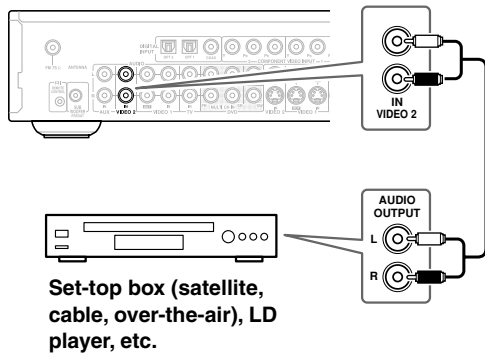

■ Using Analog Connections

Even if your CD player is connected digitally (coaxial or optical), to use **RI**, or to record from it, you'll need to make analog audio connections as well.

Use an analog audio cable to connect the TX-L55's AUDIO AUX IN L/R inputs to the analog audio outputs on your CD player, as shown.

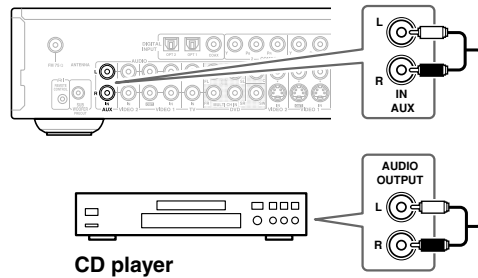

Connecting a CD Player

Music CDs don't support Dolby Digital, so you can connect your CD player to either a digital or analog audio input and enjoy surround sound listening modes such as Dolby Pro Logic IIx.

■ Using a Coaxial or Optical Connection

- Use a coaxial digital audio cable to connect the TX-L55's COAX DIGITAL INPUT to the coaxial output on your CD player, as shown.

OR

- Use an optical digital audio cable to connect the TX-L55's OPT 2 DIGITAL INPUT to the optical output on your CD player, as shown.

Notes:

- Initially, the AUX input source is not assigned to any of the digital audio inputs. If you connect your CD player to a digital input, you'll need to change the AUX input source assignment (see page 31).

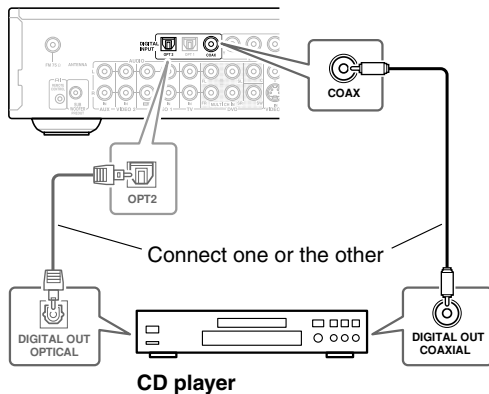

Connecting a CD, MiniDisc, DAT, or Cassette Recorder

You can connect a CD, MiniDisc, DAT, or cassette recorder for audio recording.

Only audio connected via the following analog AUDIO inputs can be recorded: DVD MULTI CH IN FL/FR, TV IN, VIDEO 2 IN, AUX IN.

■ Using Analog Connections

Use an analog audio cable to connect the TX-L55's AUDIO VIDEO 1 IN L/R inputs to the recorder's outputs, and use another analog audio cable to connect the TX-L55's AUDIO VIDEO 1 OUT L/R outputs to the recorder's inputs, as shown.

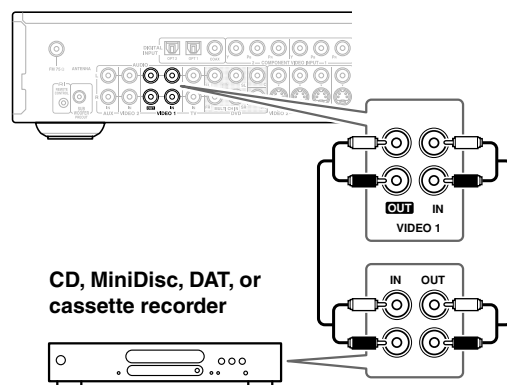

Connecting AV Components—Continued

■ Using a Coaxial or Optical Connection for Playback from Your Digital Recorder

- Use an optical digital audio cable to connect the TX-L55's OPT 2 DIGITAL INPUT to the optical output on your recorder, as shown.

OR

- Use a coaxial digital audio cable to connect the TX-L55's COAX DIGITAL INPUT to the coaxial output on your recorder, as shown.

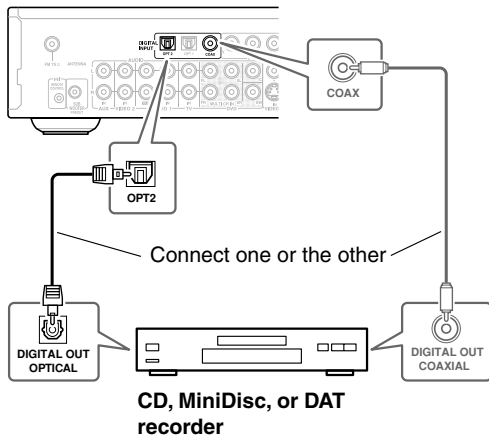

Connecting a Turntable

■ Turntable with a Built-in Phono Preamp

Use an analog audio cable to connect the TX-L55's AUDIO AUX IN L/R inputs to the audio outputs on your turntable, as shown.

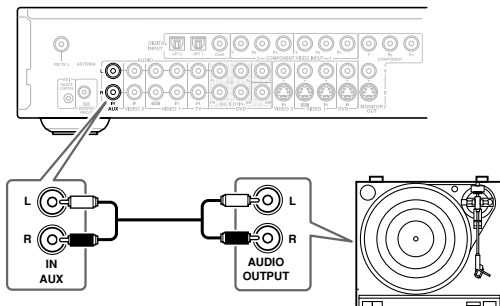

■ Turntable without a Built-in Phono Preamp

Use an analog audio cable to connect the TX-L55's AUDIO AUX IN L/R inputs to the audio outputs on your phono preamp, and use another analog audio cable to connect the phono preamp's inputs to your turntable, as shown.

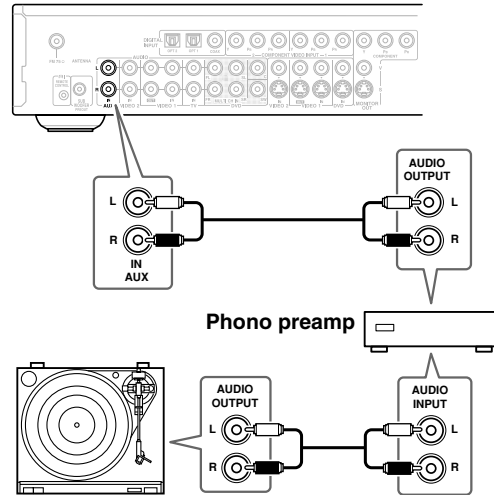

■ Turntable with an MC (Moving Coil) Cartridge

Use an analog audio cable to connect the TX-L55's AUDIO AUX IN L/R inputs to the audio outputs on your phono preamp. Use another analog audio cable to connect the phono preamp's inputs to your MC head amp's outputs. And use another analog audio cable to connect the MC head amp's inputs to your turntable, as shown.

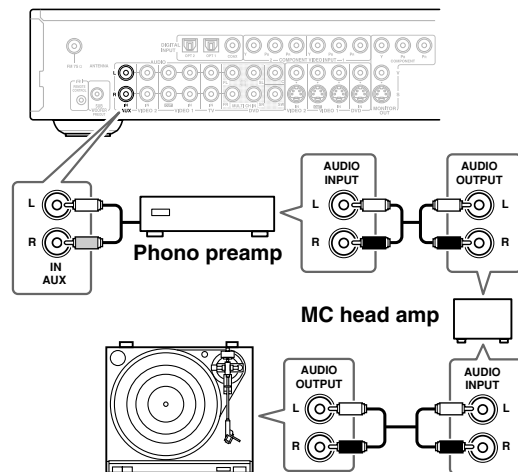

Connecting AV Components—Continued

Connecting an Onkyo DVD Player with **RI**

To use **RI**, you must make an analog audio connection (RCA) between the TX-L55 and the other component, even if they are connected digitally.

With **RI** (Remote Interactive) you can control your **RI**-compatible Onkyo DVD player with the TX-L55's remote controller, and use the following special **RI** functions:

Auto Power On/Standby

When you start playback on the DVD player, if the TX-L55 is in Standby, it will turn on and select the DVD player as the input source automatically. Similarly, when the TX-L55 is set to Standby, the DVD player will also enter Standby.

Direct Change

When playback is started on the DVD player, the TX-L55 will automatically select it as the input source.

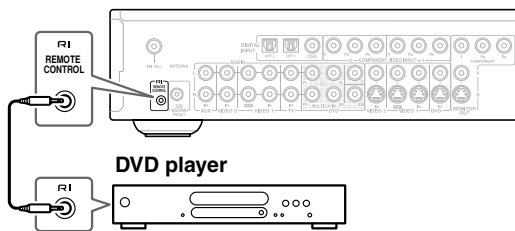

Notes:

- Push plugs in all the way to make good connections.
- Use only **RI** cables for **RI** connections. An **RI** cable is supplied with each **RI**-compatible Onkyo DVD player.
- Some DVD players have two **RI** sockets, you can connect either one to the TX-L55. The other is for connecting additional **RI**-compatible components.
- Connect the TX-L55's **RI** socket to only an Onkyo DVD player. Connecting to other manufacturer's components may cause them to malfunction.
- Some DVD players may not support all **RI** functions. Refer to the manual supplied with your DVD player.

Connecting the Power Cord

Notes:

- Before connecting the power cord, connect all of your speakers and AV components.
- Turning on the TX-L55 may cause a momentary power surge that might interfere with other electrical equipment on the same circuit. If this is a problem, plug the TX-L55 into a different branch circuit.

Turning On the TX-L55

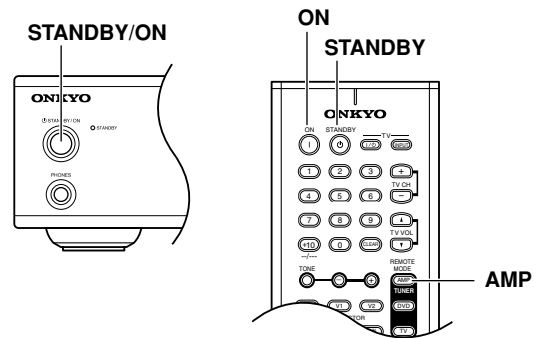

STANDBY/ON



Remote controller

ON



STANDBY



Press the [STANDBY/ON] button. Alternatively, press the remote controller's REMOTE MODE [AMP] button followed by the [ON] button.

The TX-L55 comes on, the display lights up, and the STANDBY indicator goes off.

To turn on a DVD player that's connected via **RI**, press the [ON] button again.

To turn off the TX-L55, press the [STANDBY/ON] button. The TX-L55 will enter Standby mode. To prevent any loud surprises the next time you turn on your TX-L55, always turn down the volume before turning it off.

Basic Setup

This chapter explains the basic settings you need to make to get the TX-L55 up and running.

Speaker Setup

Speaker Detection

The TX-L55 can automatically detect which speakers you've connected to it (front, center, surround, and surround back).

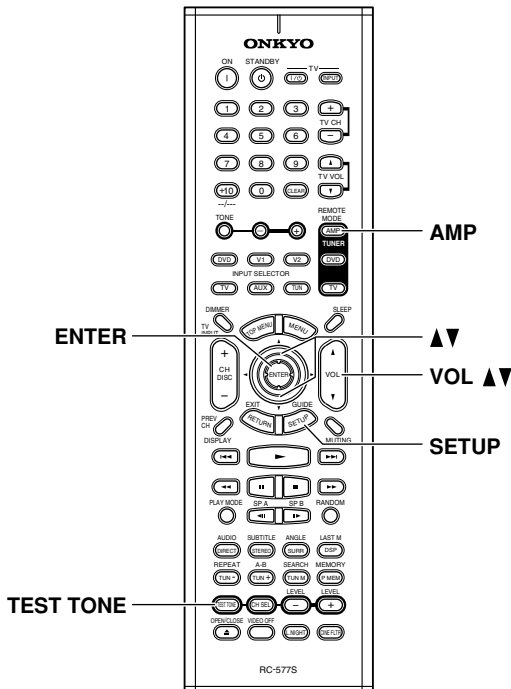

3



Press [ENTER].

The connected speakers are detected automatically, and the results appear on the display, as shown.

Y: Speaker connected.

N: No speaker connected.

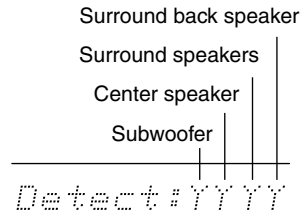

Notes:

- Always use two surround speakers (left and right).
- Only connect a surround back speaker if you've already connected two surround speakers. If no surround speakers are connected, the surround back speaker will not work.
- When this SP Detect function is used, the Speaker Configuration settings (pages 48–49) will change.

Speaker Level Calibration (Test Tone)

You can adjust the volume of each speaker so that all speakers can be heard equally at the listening position.

- The individual speaker levels cannot be adjusted while the TX-L55 is muted, a pair of headphones is connected, or the DVD multichannel input is selected.

1



Press the REMOTE MODE [AMP] button followed by the [SETUP] button.

2



Use the Up and Down [▲]/[▼] buttons to select "0. SP Detect," and then press [ENTER]. "SP Detect?" appears on the display.

1



Press the REMOTE MODE [AMP] button followed by the [TEST TONE] button.

The test tone is output by the front left speaker.

2



Turn up the volume so that you can hear the test tone sufficiently.

While each speaker outputs the test tone, its name appears on the display, as shown.

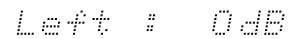

Basic Setup—Continued

- 3** Use the [CH SEL] button to select the speakers, and use the [LEVEL+] and [LEVEL-] buttons to adjust the volume.

The level can be adjusted from -12 to +12 dB in 1 dB steps.

If you don't press anything for two seconds, the next speaker will be selected automatically.
- 4** Repeat step 3 until the volume of the test tone coming from each speaker is the same.

Speakers that you set to No or Non in the Speaker Configuration (page 48) do not output the test tone.
- 5** Press the [TEST TONE] button.

The setup menu closes.

Don't forget to turn down the volume if you turned it up while setting the levels.

Notes:

- This procedure can also be performed by using the [SETUP] button. Press the REMOTE MODE [AMP] button followed by the [SETUP] button. Use the Up and Down [▲]/[▼] buttons to select "Level Cal," and then press [ENTER]. Use the Left and Right [◀]/[▶] buttons to adjust the speaker volume, and use the Down [▼] button to select the next speaker. Unlike the above procedure, the next speaker will not be selected automatically after two seconds.

Assigning Inputs to Input Sources

Digital Audio Input Setup

To enjoy Dolby Digital and DTS, you must connect your DVD player to the TX-L55 by using a digital audio connection (coaxial or optical).

This section explains how to change the digital audio input socket to input source assignments. You only need to change them if your connections don't match the defaults listed in the following table.

Input source	Default digital input assignment
DVD	COAX
TV	OPT1
VIDEO1	OPT2
VIDEO2	---- (Analog)
AUX	---- (Analog)

For example, if you connect your DVD player to the OPT 1 DIGITAL INPUT, you'll need to change the DVD input source from COAX to OPT 1.

If you want to use the TV input source with only the analog TV IN, change the TV input source assignment from OPT1 to "----" (Analog).

You can change the assignments as follows.

- 1** Press the REMOTE MODE [AMP] button followed by the [INPUT SELECTOR] button for the input source whose assignment you want to change.

There is no assignment for the TUNER input source.
- 2** Press the [SETUP] button.
- 3** Use the Up and Down [▲]/[▼] buttons to select "Input Set," and then press [ENTER].
- 4** Use the Up and Down [▲]/[▼] buttons to select "Digital In," and then use the Left and Right [◀]/[▶] buttons to select:

COAX: Select if the component is connected to the COAX DIGITAL INPUT.

OPT1: Select if the component is connected to the OPT1 DIGITAL INPUT.

OPT2: Select if the component is connected to the OPT2 DIGITAL INPUT.
- 5** Press the [SETUP] button.

The setup menu closes.

Basic Setup—Continued

Component Video Input Setup

This section explains how to change the component video input socket to input source assignments. You only need to change them if you connect a video component to a component video input other than the default assignment listed in the following table. There are no other reasons to change these assignments.

Input source	Default component video input assignment	Analog audio input (cannot be changed)
DVD	INPUT1	DVD
VIDEO 1	INPUT2	VIDEO 1
VIDEO 2	INPUT2	VIDEO 2
TV	Last	TV
AUX	Last	AUX
FM	Last	—

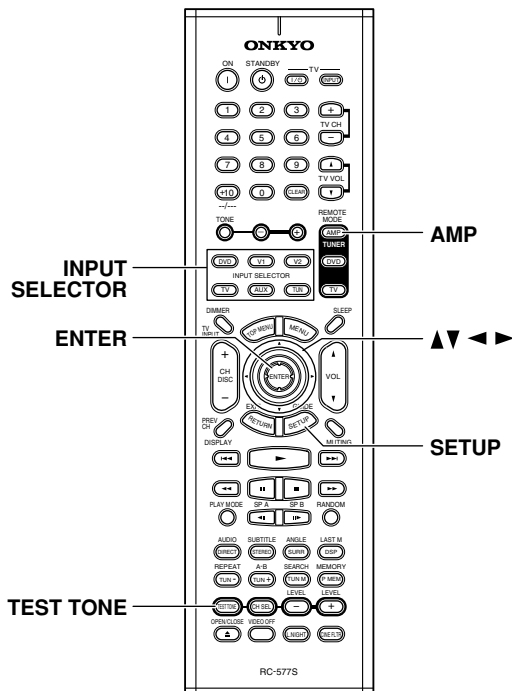

1 Press the **REMOTE MODE [AMP]** button followed by the **[INPUT SELECTOR]** button for the input source whose assignment you want to change.

2 Press the **[SETUP]** button.

3 Use the **Up and Down [▲]/[▼]** buttons to select “4. Input Setup,” and then press **[ENTER]**.

4 Use the **Up and Down [▲]/[▼]** buttons to select “Component Video,” and then use the **Left and Right [◀]/[▶]** buttons to select:

- Input1:** Select if the video component is connected to COMPONENT VIDEO INPUT 1.
- Input2:** Select if the video component is connected to COMPONENT VIDEO INPUT 2.
- Last:** Select if you want to watch video from the previously selected component.

5 Press the **[SETUP]** button. The setup menu closes.

Notes:

When an input source that’s set to Last is selected, the video source remains the same. For example, if you set the VIDEO 1 input source to Last, then select the DVD input source, then select the VIDEO 1 input source, you can watch a DVD while listening to audio from the component connected to the VIDEO 1 audio inputs.

Basic Operation

Selecting the Input Source

This section explains how to select the input source (i.e., AV component) that you want to listen to or watch.

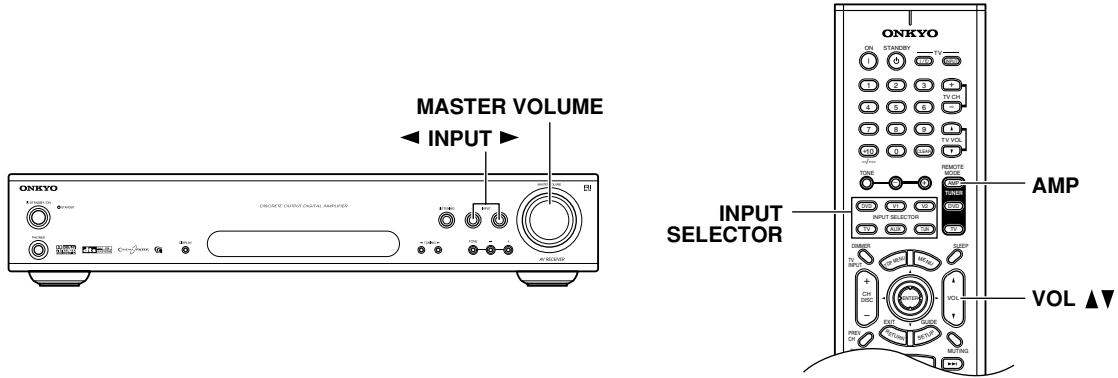

- 1**

TX-L55

or

Remote controller

Use the TX-L55's INPUT [◀]/[▶] buttons to select the input source.

To select the input source with the remote controller, press the REMOTE MODE [AMP] button, and then use the INPUT SELECTOR buttons.

- 2**

Start playback on the source component.

When you select DVD or another video component, on your TV you'll need to select the video input to which the TX-L55 is connected.

On some DVD players, you may need to turn the digital audio output on.

- 3**

TX-L55

or

Remote controller

To adjust the volume, use the MASTER VOLUME control, or the remote controller's [VOL] button.

The volume can be set to MIN, 1 through 79, or MAX.

The TX-L55 is designed for home theater enjoyment. It has a wide volume range, allowing precise adjustment.

Basic Operation—Continued

This chapter explains functions that can be used with any input source.

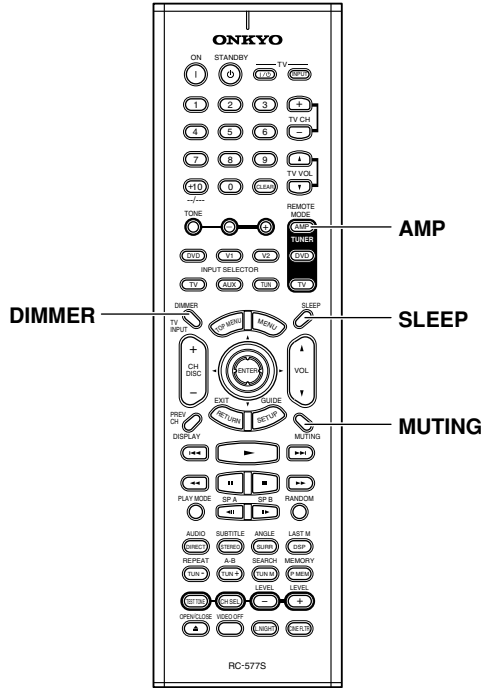

Muting the TX-L55

You can temporarily mute the output of the TX-L55.

Press the REMOTE MODE [AMP] button, and then press the [MUTING] button.

The output is muted and the MUTING indicator flashes on the display, as shown.

To unmute the TX-L55, press the [MUTING] button again, or adjust the volume.

The Mute function is cancelled when the TX-L55 is set to Standby.

Notes:

- The [MUTING] button can also be used to mute the TX-L55 while the remote controller is in DVD mode (see page 12).

Setting the Display Brightness

You can adjust the brightness of the display.

Press the REMOTE MODE [AMP] button, and then press the [DIMMER] button repeatedly to select: dim, dimmer, dimmer+front panel indicators off, or normal brightness.

Basic Operation—Continued

Using the Sleep Timer

With the sleep timer you can set the TX-L55 to automatically turn off after a specified period.



Press the REMOTE MODE [AMP] button, and then press the [SLEEP] button repeatedly to select the required sleep time.

You can set the sleep time from 90 to 10 minutes in 10 minute steps.

The SLEEP indicator appears on the display when the sleep timer has been set, as shown. The specified sleep time appears on the display for about five seconds, then the previous display reappears.

SLEEP indicator

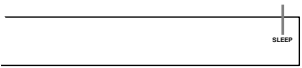

If you need to cancel the sleep timer, press the [SLEEP] button repeatedly until the SLEEP indicator disappears.

To check the time remaining until the TX-L55 sleeps, press the [SLEEP] button. Note that if you press the [SLEEP] button while the sleep time is being displayed, you'll shorten the sleep time by 10 minutes.

Using Headphones

You can connect a pair of stereo headphones (1/4-inch phone plug) to the TX-L55's PHONES jack for private listening, as shown.

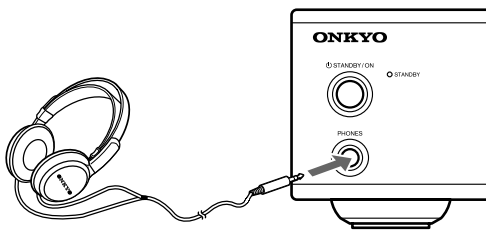

Notes:

- Always turn down the volume before connecting your headphones.
- The speakers are turned off while the headphones plug is inserted in the PHONES jack.
- When you connect a pair of headphones, the listening mode is set to Stereo, unless it's already set to Stereo or Direct. When you disconnect the headphones, the previous listening mode is resumed.
- When the DVD multichannel input is selected, only the front left and front right audio can be heard in the headphones.

Basic Operation—Continued

Listening to the Radio

With the built-in tuner you can enjoy FM radio stations, and store your favorite stations as presets for quick selection.

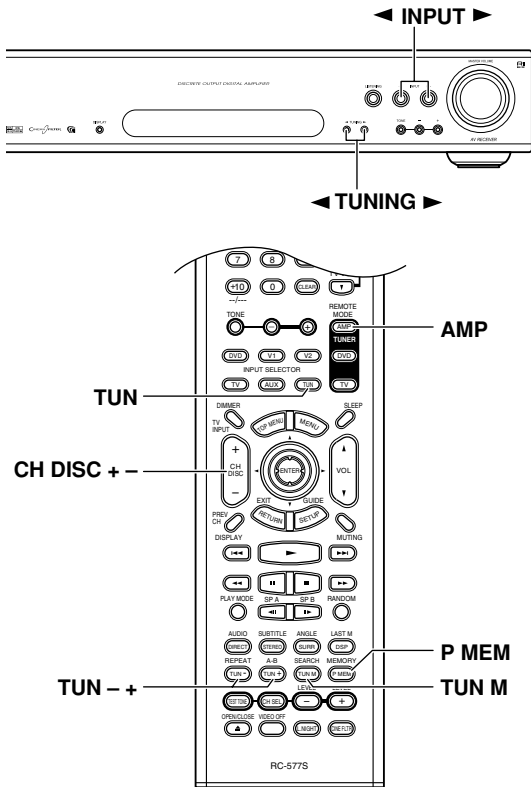

Tuning with the Remote Controller

In Auto Tuning mode, the TX-L55 finds available radio stations automatically. In Manual Tuning mode, you can tune into radio stations by frequency.

■ Auto Tuning Mode

- 1** Press the **REMOTE MODE [AMP]** button, then press the **[TUN] INPUT SELECTOR** button to select FM.
- 2** Press the **[TUN M]** button repeatedly until the **AUTO** indicator appears on the display. Auto Tuning mode is now selected.
- 3** Press the **[TUN-]** or **[TUN+]** button. The TX-L55 searches for a radio station, and stops when it finds one. Press the **[TUN-]** or **[TUN+]** button again to search for the next available radio station.

When tuned into a station, the ►●◀ indicator appears on the display. When tuned into a stereo FM station (Auto Tuning mode only), the FM STEREO indicator appears as well.

Tuning on the TX-L55

- 1** Use the TX-L55's **INPUT [◀]/[▶]** buttons to select FM.

Band Frequency
- 2** Use the **TUNING [◀]/[▶]** buttons to tune into a radio station. If the **AUTO** indicator is shown on the display, the TX-L55 will automatically find a radio station. If the **AUTO** indicator is not shown, the frequency will change in steps. Use the remote controller's **[TUN M]** button to turn **AUTO** on or off.

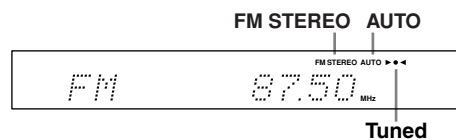

Basic Operation—Continued

Manual Tuning Mode

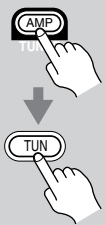
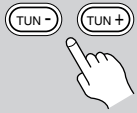
<p>1</p> 	<p>Press the REMOTE MODE [AMP] button, then press the [TUN] INPUT SELECTOR button to select FM.</p>
<p>2</p>	<p>Press the [TUN M] button repeatedly until the AUTO indicator disappears from the display. Manual Tuning mode is now selected.</p>
<p>3</p> 	<p>Use the [TUN-] and [TUN+] buttons to tune into a radio station by frequency. Press and hold these buttons to change the frequency continually. Press once to change the frequency one step at a time. Check your local radio guide for the frequencies of the stations available in your area.</p>

Notes:

- The American model changes FM frequency in 0.1 MHz steps.
- Other models change frequency in 0.05 MHz steps for FM.
- In Manual Tuning mode, FM stations will be in mono. Switch back to Auto Tuning mode for stereo.

Tuning into weak FM stations





If the signal from a stereo FM station is weak, it may be impossible to get good reception. In this case, switch to Manual Tuning mode and listen to the station in mono.

Using RDS (European model only)

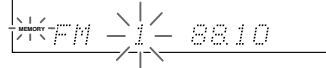

When tuned into an RDS (Radio Data System) station that's broadcasting PS (Program Service Name) information, the RDS indicator appears and the name of the station appears on the display. Only European models support RDS, and only in areas where RDS is used.

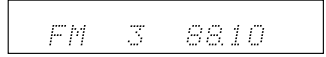
Presetting Radio Stations

You can store up to 30 radio stations as presets.

<p>1</p>	<p>Tune into the station that you want to store as a preset.</p>
<p>2</p> 	<p>Press the [P MEM] button. The MEMORY indicator appears and the preset number flashes.</p> 
<p>3</p> 	<p>While the MEMORY indicator is displayed, use the CH [+/-] button to select a preset from 1 through 30. In this example, preset #3 is selected.</p> 
<p>4</p> 	<p>Press the [P MEM] button again to store the station. The station is stored and the preset number stops flashing. Repeat this procedure for all of your favorite radio stations.</p>

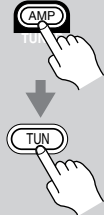
Selecting Preset Stations

<p>1</p> 	<p>Press the REMOTE MODE [AMP] button, then press the [TUN] INPUT SELECTOR button to select FM.</p>
<p>2</p> 	<p>Use the CH [+/-] button to select the presets.</p>

Basic Operation—Continued

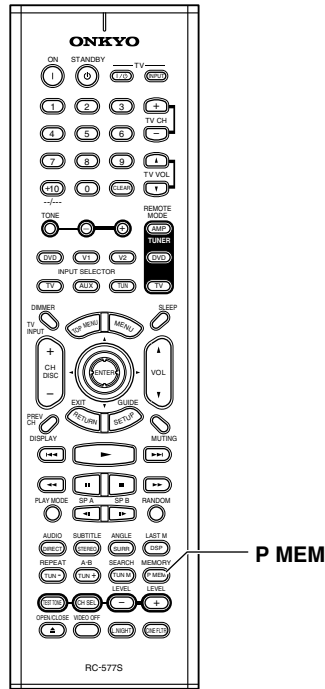

Displaying Radio Information

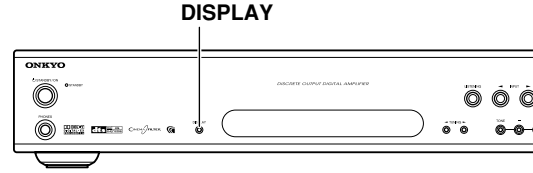

1 **DISPLAY** Press the [DISPLAY] button repeatedly to cycle through the available information.

When the input source is FM:



When tuned to an RDS radio station broadcasting PS information (European models only):

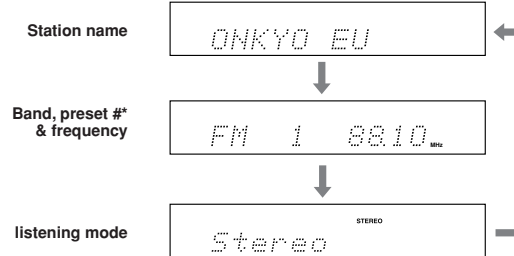

*This information is displayed for about five seconds, then the previously displayed information reappears.

Deleting Presets

- 1** Select the preset that you want to delete (see the previous section).
- 2** Press the [P MEM] button. "Erase" flashes on the display.
- 3** While it's flashing, press the [P MEM] button again. The selected preset is deleted and its number disappears from the display.

Using the Listening Modes

With its comprehensive collection of surround and DSP listening modes, the TX-L55 can transform your home listening room in to a movie theater or concert hall.

To get the most from surround sound, it's important that you install and configure your speakers correctly. See "Connecting Speakers" on page 16 and "Speaker Configuration" on page 48.

Selecting Listening Modes

- The Dolby Digital and DTS listening modes can be selected only if your DVD player is connected to the TX-L55 with a digital audio connection (coaxial or optical).
- The listening modes available depends on the format of the input signal.
- While the DVD multichannel input is selected, only the Direct listening mode can be selected.

Selecting on the TX-L55

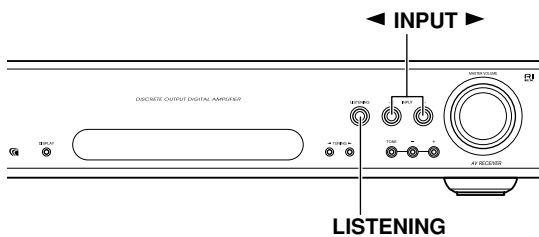

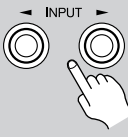

- 

1 Use the INPUT [◀/▶] buttons to select the input source.
- 2** Start playback on the selected AV component.
- 

3 Press the [LISTENING] button repeatedly to select the listening modes.
The listening modes available depends on the format of the input signal. The Dolby Digital/DTS setting (page 43) also affect which surround modes can be selected.

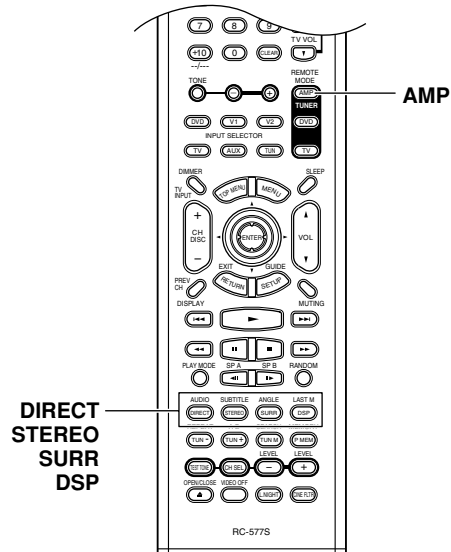
Selecting with the Remote Controller



- 

1 Press the REMOTE MODE [AMP] button, and then use the INPUT SELECTOR buttons to select an input source.
- 2** Start playback on the selected AV component.
- 

3 Press the REMOTE MODE [AMP] button, and then use the [DIRECT], [STEREO], [SURR], and [DSP] buttons to select the listening modes.



- **[DIRECT] button**
This button selects the Direct listening mode.
- **[STEREO] button**
This button selects the Stereo listening mode.
- **[SURR] button**
This button selects the Dolby Digital and DTS listening modes. The modes available depends on the Dolby Digital/DTS setting (see page 43). When the DVD multichannel input is selected, this button is used when adjusting the bass and treble (see page 52).
- **[DSP] button**
This button selects the Onkyo original DSP modes and the Mono mode.

Using the Listening Modes—Continued

About the Listening Modes

The TX-L55's surround indicators show which speakers are active in each listening mode.

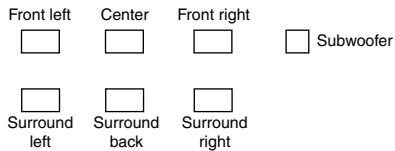

Basic Modes

Mono

Use this mode when watching an old movie with a mono soundtrack, or to select the multilingual soundtracks recorded in the left and right channels of some movies. It can also be used when playing a DVD or other source with multiplexed audio, such as a karaoke DVD.

Direct

The selected input source is output by the front left and right speakers only, with minimal processing for a pure sound.

Stereo

The selected input source is processed as a stereo signal and output by the front left and right speakers and the subwoofer.

Surround Modes

Dolby Pro Logic II

Dolby Pro Logic II creates 5.1-channel surround from two-channel material.



- **Dolby Pro Logic II Movie**
Use this mode with DVDs and videos that bear the Dolby Surround logo or TV programs that feature Dolby Surround. You can also use this mode with stereo movies or TV programs. 
- **Dolby Pro Logic II Music**
Use this mode with the stereo sources such as music CDs and DVDs.
- **Dolby Pro Logic II Game**
Use this mode with video games that feature stereo sound.

Dolby Pro Logic IIx

Dolby Pro Logic IIx can create 6.1-channel surround from two-channel material (except 96 kHz PCM). The Dolby Pro Logic IIx Music mode can create 6.1-channel surround from 5.1-channel audio material.

- **Dolby Pro Logic IIx Movie**
Use this mode with DVDs and videos that bear the Dolby Surround logo  or TV programs that feature Dolby Surround. You can also use

this mode with stereo movies, TV programs, or other 2-channel sources.

- **Dolby Pro Logic IIx Music**
Use this mode with CDs and DVDs that bear the Dolby Surround  or Dolby Digital  logo. It can also be used with other 5.1-channel sources to create 6.1-channel surround.
- **Dolby Pro Logic IIx Game**
Use this mode with video games that feature stereo sound.

Neo:6

This mode creates 6.1-channel surround from 2-channel analog sources. It offers six full-bandwidth channels with excellent separation. There are two modes of operation: *Cinema mode*, which is suited to movies, and *Music mode*, which is for listening to music.

- Cinema mode simulates the realistic sense of movement that you get with 6.1-channel surround sound sources. Use this mode with videos, DVDs, and TV programs that feature stereo sound.
- Music mode uses the surround channels to simulate a natural sound field that cannot be produced with conventional stereo. Use this mode with stereo source material such as music CDs.

Dolby Digital

With this format you can experience the same superb sound that you get at a movie theater or concert hall. Use this mode with DVDs that bear the Dolby Digital logo. 

Dolby Digital EX

With an added surround-back channel, this 6.1 channel format offers a heightened sense of space, for added realism with moving sounds, such as those that rotate 360 degrees or pass overhead. Dolby Digital EX material can also be played on conventional 5.1 channel systems, in which case the surround-back channel audio is divided between the surround left and right channels. Use this mode with DVDs that have a 6.1-channel soundtrack and bear the Dolby Digital logo. 

DTS

This digital surround format offers a surround sound experience with exceptional fidelity. It uses compressed digital audio data, with six discrete channels (5.1), and has the ability to handle large amounts of audio data while remaining faithful to the original. DTS provides very high-quality sound. You'll need a DTS compatible DVD player in order to enjoy DTS material. Use this mode with DVDs, LDs, or CDs that bear the DTS logo. 

DTS 96/24

This mode provides better audio quality. Use it with CDs, DVDs, and LDs that bear the DTS 96/24  logo.

Using the Listening Modes—Continued

DTS-ES

DTS-ES supports up to 6.1 channels. The TX-L55 supports both *DTS-ES Discrete* and *DTS-ES Matrix*.

Discrete mode is for use with DTS 6.1 material. With an additional surround-back channel, each 6.1 channel is digitally recorded for a realistic sense of movement and space. Use it with CDs, DVDs, and LDs that bear the DTS-ES logo.



Matrix mode creates 6.1-channel surround from DTS 5.1 material. Since DTS 5.1 includes surround-back channel information, the channel can be reconstructed for playback on 6.1-channel systems. Use this mode with CDs, DVDs, and LDs that bear the DTS-ES or DTS logo.



DTS+Neo:6

This mode uses the Neo:6 decoder to create 6.1-channel surround from DTS 5.1-channel material. Use it with CDs, DVDs, and LDs that bear the DTS or DTS 96/24 logo.

DTS+Dolby EX

This mode uses the Dolby EX decoder to create 6.1-channel surround from DTS 5.1-channel material. Use it with CDs, DVDs, and LDs that bear the DTS or DTS 96/24 logo.

Onkyo Original DSP Modes

Orchestra

Suitable for classical or operatic music. The center speaker is turned off and the surround channels are emphasized in order to widen the stereo image. In addition, it simulates the natural reverberation of a large hall.

Unplugged

Suitable for acoustic instrument sounds, vocals, and jazz music. By emphasizing the front stereo image, it simulates the stage-front experience.

Studio-Mix

Suitable for rock and pop music. Listening to music in this mode creates a lively sound field with a powerful acoustic image, like being at a club or rock concert.

TV Logic











Adds realistic acoustics to TV programs produced in a TV studio. In addition, it adds surround effects to the entire sound and clarity to voices.

All Ch Stereo

Ideal for background music, stereo audio is output by the front, surround, and surround back channels, filling the entire listening area.

Listening Mode Indicators

The following table shows the display indication for each listening mode.

Listening mode	Display
Direct	DIRECT
Stereo	STEREO
PL II Movie/Music/Game	 PRO LOGIC II
PL IIx Movie/Music/Game	 PRO LOGIC II
Neo:6 Cinema/Music	dts Neo:6
Dolby Digital	 DIGITAL
Dolby Digital EX	 DIGITAL  EX
DTS, DTS 96/24	
DTS-ES	
DTS+Neo:6	 dts Neo:6
DTS+Dolby EX	  EX
Onkyo original DSP	DSP

Using the Listening Modes—Continued

Input Signal Formats & Listening Modes

The following table lists all of the listening modes and indicates which ones can be used with each signal format.

About the “Speakers necessary” Column

- 2 or more: can be selected with any speaker setup.
- 3 or more: can be selected only if you’re using a center speaker or surround speaker.
- 4 or more: can be selected only if you’re using surround speakers.
- With surr bk: can be selected only if you’re using a surround back speaker.
- ○: can be selected if the Dolby Digital/DTS setting is set to “On” (see page 43).
- : can be selected if the Dolby Digital/DTS setting is set to either “On” or “Auto” (see page 43).

Mode button	Input signal format		PCM/analog	PCM 96 kHz	Dolby Digital			DTS				
	Listening mode	Input source Speakers necessary			Cassette, CD, video, radio, TV, LD, etc	DVD 96k/24bit, etc	3/2.1, etc	2/0 (stereo)	1/0 (mono)	3/2.1, etc	2/0 (stereo)	96/24 ¹
			DVD-Video, etc				DVD-Video, LD, CD, etc					
[DIRECT]	Direct		●	●								
[STEREO]	Stereo	2 or more	●	●	●	●	●	●	●	● ²	●	
	Main+Sub											
	Main											
	Sub											
[SURROUND]	Dolby Pro Logic II	3 or more	●			●				●		
			●			●			●			
			●			●			●			
	Dolby Pro Logic IIx	With surr bk	●			●			●			
			●		○ ○	●		○ ○	●			
			●			●			●			
	Neo:6 Cinema	3 or more	●									
	Neo:6 Music	4 or more	●									
	Dolby Digital	3 or more			●		●					
	Dolby Digital EX	With surr bk			○							
	DTS	3 or more						●			●	
	DTS 96/24	3 or more								●		
	DTS-ES Discrete	With surr bk										○ (Discrete)
	DTS-ES Matrix											○ (Matrix)
DTS+Neo:6							○ ○		○ ○			
DTS+Dolby EX							○ ○		○ ○			
[DSP]	Onkyo original DSP modes	2 or more	●									
		Orchestra	4 or more	●								
		Unplugged	4 or more	●								
		Studio-Mix	4 or more	●								
		TV Logic	4 or more	●								
		All Ch St	4 or more	●								

1. For DTS 96 kHz/24-bit material, if the listening mode is Stereo or DTS 96/24, audio is processed at 96 kHz. For all other listening modes, it’s processed at 48 kHz.
2. “DTS96Stereo” will appear on the display.
3. If you’re using surround back speakers, the Dolby Pro Logic IIx modes will be used instead.

Tip: To check the format of the input signal, see “Displaying Source Information” on page 46.

What to Do If You Can’t Select a Listening Mode

- Is the source component connected digitally? The Dolby Digital and DTS listening modes can be selected only if your DVD player is connected to the TX-L55 with a digital audio (coaxial or optical) connection (see page 23).
- The Dolby Digital or DTS listening modes can be selected only when the input signal is Dolby Digital or DTS, respectively.
- Check the digital output settings on the source component. If the digital output is set to PCM, change it so that other signal formats can be output as well.

Using the Listening Modes—Continued

Dolby Digital/DTS Setting (5.1- or 6.1-channel Playback)

This setting determines if Dolby Digital and DTS material is played using 6.1-channels or 5.1-channels. This setting only applies when you're using a surround back speaker, the Speaker Configuration Surr Back setting is set to something other than Non (page 48), and the surround information in the current digital input signal is 3/2.1 or 3/3.1. To check the format of a digital input signal, see "Displaying Source Information" on page 46.

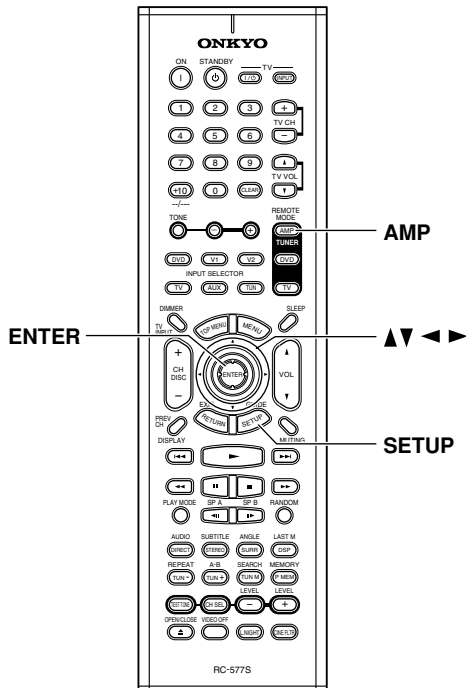

1 Press the **REMOTE MODE [AMP]** button followed by the **[SETUP]** button.

2 Use the Up and Down [**▲**]/[**▼**] buttons to select "5. Audio Adj.," and then press **[ENTER]**.

3 Use the Up and Down [**▲**]/[**▼**] buttons to select "Surr Bk," and then use the Left and Right [**◀**]/[**▶**] buttons to select Auto, On, or Off.

4 Press the **[SETUP]** button. The setup menu closes.

This setting affects Dolby Digital and DTS sources as follows:

Dolby Digital

- Auto:** If the source signal contains a Dolby Digital EX flag, Dolby Digital EX 6.1 is used. If not, Dolby Digital 5.1 is used.
- On:** Dolby Digital EX 6.1 is used regardless of whether the source signal contains a Dolby Digital EX flag. You can choose Dolby Digital EX or PL IIx Music mode with the [SURR] button.
- Off:** Dolby Digital 5.1 is used even if a Dolby Digital EX flag is present.

DTS

- Auto:** If the source signal contains a DTS-ES flag, DTS-ES Discrete (6.1) or DTS-ES Matrix (6.1) is selected automatically. If not, DTS 5.1 is used.
- On:** DTS-ES 6.1 is used regardless of whether the source signal contains a DTS-ES flag. If the source signal contains a DTS-ES flag, DTS-ES Discrete (6.1) or DTS-ES Matrix (6.1) is selected automatically. If the source signal does not contain a DTS-ES flag, you can choose DTS+Dolby EX, PL IIx Music, or DTS+Neo:6 with the [SURR] button.
- Off:** DTS 5.1 is used for all DTS sources, even if a DTS-ES flag is present.

Advanced Operation

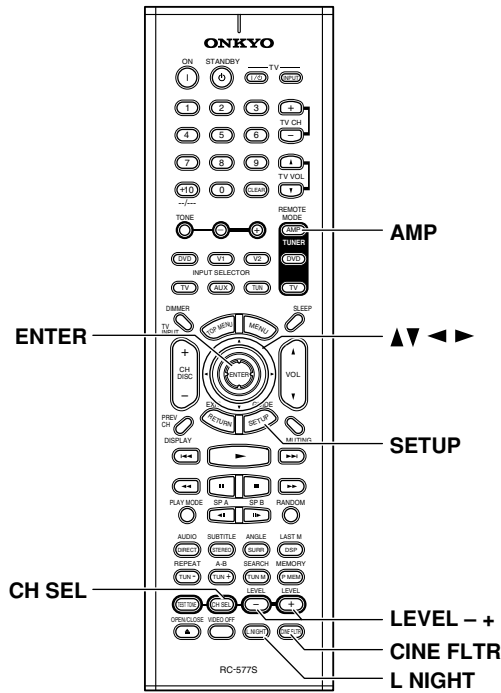

Using the Late Night Function (Dolby Digital only)

With the Late Night function you can reduce the dynamic range of Dolby Digital material so that you can still hear quiet parts even when listening at low volume levels—ideal for watching movies late at night when you don't want to disturb anyone.

1 Press the **REMOTE MODE [AMP]** button, and then press the **[L NIGHT]** button repeatedly to select:

- Off:** Late Night function off.
- Low:** Small reduction in dynamic range.
- High:** Big reduction in dynamic range.

Notes:

- This function also appears in the audio adjust functions (see page 52).
- The effect of the Late Night function depends on the Dolby Digital material that you are playing, and with some material there will be little or no effect.
- The Late Night function is turned off when the TX-L55 is set to Standby.

Adjusting Speaker Levels

You can adjust the level of individual speakers. The adjustments are temporary and will be cancelled when the TX-L55 is set to Standby.

1 Press the **REMOTE MODE [AMP]** button, use the **[CH SEL]** button to select each speaker, and use the **[LEVEL-]** and **[LEVEL+]** buttons to adjust the volume.

Speakers are selected in the following order: Left → Center → Right → Surr Right → Surr Back → Surr Left → Subwoofer.

You can adjust the volume of each speaker from -12 to +12. The name of the currently selected speaker and its volume appear on the display, as shown.

Left # 0dB

Notes:

- You cannot use this function while the TX-L55 is muted.
- Speakers that are set to No or Non in the Speaker Configuration cannot be adjusted.

Using the CinemaFILTER

With the CinemaFILTER you can soften overly bright movie soundtracks, which are typically mixed for reproduction in a movie theater.

CinemaFILTER can be used with the following listening modes: Dolby Digital, Dolby Digital EX, Dolby Pro Logic IIx Movie, DTS, DTS-ES, DTS Neo:6 Cinema, DTS 96/24, DTS+Neo:6, and DTS+Dolby EX.

1 Press the **REMOTE MODE [AMP]** button, and then press the **[CINE FLTR]** button repeatedly to select:

- On:** CinemaFILTER on.
- Off:** CinemaFILTER off.

Notes:

- This function also appears in the audio adjust functions (see page 52).





Advanced Operation—Continued

Using the DVD Multichannel Input

The DVD multichannel input is for connecting a component with individual 5.1-channel analog audio outputs, such as a DVD player or MPEG decoder.

See “DVD Multichannel Connection” on page 24 for hookup details.

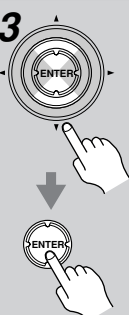
This section explains how to select the DVD multichannel input for playback.

1 	Press the INPUT SELECTOR [DVD] button. The input source changes to DVD.
2 	Press the REMOTE MODE [AMP] button followed by the [SETUP] button. The DVD multichannel input needs to be selected in the setup menus.
3 	Use the Up and Down [▲]/[▼] buttons to select “4. Input Set,” and then press [ENTER].
4  <div style="border: 1px solid black; padding: 2px; width: fit-content; margin: 5px auto;">Audio:Multi</div>	Use the Up and Down [▲]/[▼] buttons to select “Audio,” and then use the Left and Right [◀]/[▶] buttons to select “Multi.”
5 	Press the [SETUP] button. The setup menu closes.
6	Start playback on your DVD player.

Notes:

- When the DVD multichannel input (Multi) is selected, the Multichannel Direct (MLT Direct) listening mode is selected.

- While the DVD multichannel input is selected, the Speaker Configuration settings on page 48 are ignored, and signals from the multichannel input are fed to the front left, front right, center, surround left, and surround right speakers and subwoofer regardless of those settings.

Adjusting the Volume of Individual Speakers for the Multichannel Input

While using the multichannel input, you can adjust the volume of individual speakers.

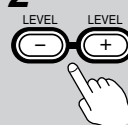
1 	Press the REMOTE MODE [AMP] button, and then use the [CH SEL] button to select each speaker. Speakers are selected in the following order: Front left → Center → Front right Subwoofer Surr left ← Surr right
2 	Use the [LEVEL-] and [LEVEL+] buttons to adjust the volume. The volume can be adjusted from -12 to +12 (-30 to +12 for the subwoofer).

Note:

- You cannot select speakers that are set to No or Non on the Speaker Configuration menu (see page 48).
- These settings are not the same as those in “Speaker Level Calibration (Test Tone)” on page 30.
- These settings affect only the DVD multichannel input and have no effect on the other inputs.

Advanced Operation—Continued

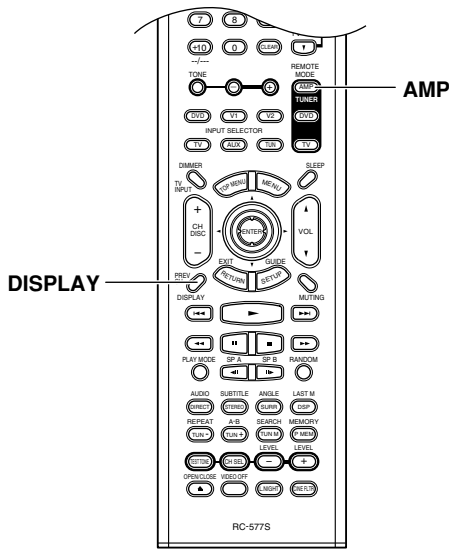

Other Digital Input Signals

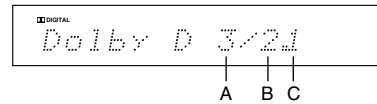
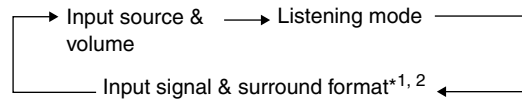

*1 If the input signal doesn't contain rate information, nothing will be displayed. The sampling rate or surround format is displayed for about three seconds. After that, the previously displayed information reappears.

*2 Surround Format Display (e.g., 3/2.1)

The surround format display works as follows:

- A:** the number of front channels.
 - 3: front left, center, and front right.
 - 2: front left and front right.
 - 1: one channel.
- B:** the number of surround channels.
 - 3: surround left, surround right, and surround back.
 - 2: surround left and surround right.
 - 1: one channel.
- C:** the presence of an LFE (Low Frequency Effects) channel.
 - 1: yes.
 - Nothing means no.

For example, 3/2.1 indicates that the input source has 5.1 channels, consisting of three front channels, two surround channels, and an LFE channel. Likewise, 3/3.1 indicates the input source has 6.1 channels, consisting of three front channels, two surround channels, a surround back channel, and an LFE channel.

Displaying Source Information

You can display information about the current input source.

Press the REMOTE MODE [AMP] button, and then press the [DISPLAY] button repeatedly to cycle through the available information.

Tip: You can also use the TX-L55's [DISPLAY] button.

The following information can typically be displayed for input sources.

Analog Input Signals

Input source & volume ↔ Listening mode

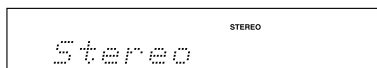

PCM Input Signals

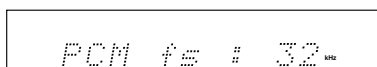
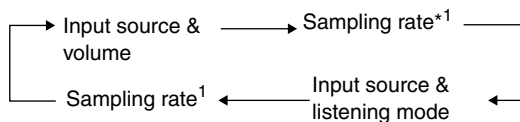

Advanced Operation—Continued

Recording

This section explains how to record to an AV component with recording capability.

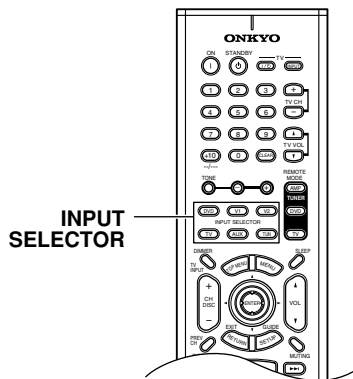
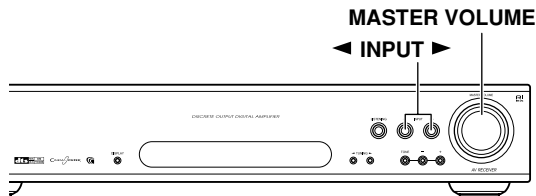

Recording the Current Input Source

You can record the audio and video, or just the audio from the current input source to an AV component connected to the VIDEO 1 OUT and AUDIO VIDEO 1 OUT sockets.

1	<p>Use the INPUT [◀]/[▶] buttons to select the input source that you want to record.</p> <p>Audio signals from the selected input source are output by the AUDIO VIDEO 1 OUT sockets.</p> <p>Video signals from the selected input source are output by the VIDEO 1 OUT sockets.</p> <p>You can listen to and watch the selected input source while recording. The TX-L55's MASTER VOLUME control has no effect on recording.</p>
2	<p>Start recording on the AV component connected to the VIDEO 1 OUT sockets.</p>
3	<p>Start playback on the source component.</p>

Notes:

- You cannot record audio from a component that's connected to a DIGITAL INPUT. You must use an analog audio input.
- Surround sound and DSP listening mode effects cannot be recorded.
- You cannot record from a component that's connected to the DVD multichannel input.
- If you select another input source while recording, that source will be recorded instead.
- Copy-protected DVDs cannot be recorded.
- DTS signals will be recorded as noise, so don't try and record from DTS CDs or LDs.

Recording from Separate AV Sources

You can record audio and video from two separate sources, allowing you to overdub audio onto your video recordings. This works because when an audio-only input source (i.e., TUNER, TV, or AUX) is selected, the video input source remains the same. For example, if you select the VIDEO 2 input source, followed by the AUX input source, you can watch video from the VIDEO 2 input while listening to audio from the AUX input.

In the following example, audio from a CD player connected to the AUX IN sockets, and video from a camcorder connected to the VIDEO 2 IN socket are recorded by a VCR, which is connected to the VIDEO 1 OUT sockets.

1	Prepare the camcorder and CD player for playback.
2	Prepare the VCR for recording.
3	<p>Select the VIDEO 2 input source.</p> <p>This selects the camcorder as the video source.</p>
4	<p>Select the AUX input source.</p> <p>This selects the CD player as the audio source, but leaves the camcorder as the video source.</p>
5	<p>Start recording on the VCR and start playback on the camcorder and CD player.</p> <p>The video from the camcorder and the audio from the CD player are recorded by the VCR.</p>

Notes:

- Audio from only the TUNER, TV, VIDEO 2, and AUX input sources can be recorded.

Advanced Setup

Settings in this chapter cannot be set while the DVD multichannel input is selected or a pair of headphones is connected to the PHONES jack.

Speaker Setup (Advanced)

Speaker Configuration

This section explains how to specify which speakers are connected and their sizes.

For speakers with a cone diameter larger than 6-1/2 inches (16 cm), specify *Lrg*. For those with a smaller diameter, specify *Sml*.

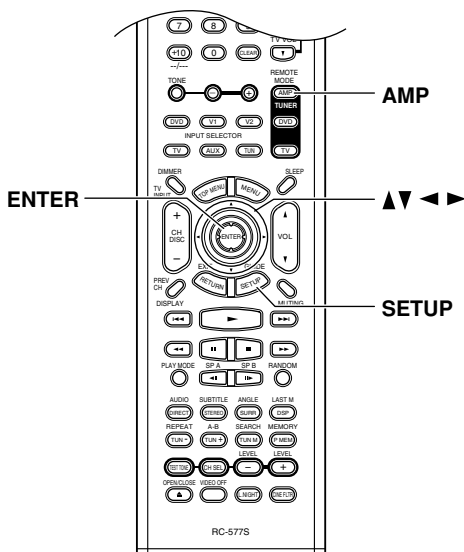
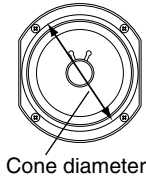

1

Press the REMOTE MODE [AMP] button followed by the [SETUP] button.

2

Use the Up and Down [▲]/[▼] buttons to select "1. SP Config," and then press [ENTER].

1. SP Config

3

While the Subwoofer setting is selected, use the Left and Right [◀]/[▶] buttons to select:

Yes: Select if a subwoofer is connected.

No: Select if no subwoofer is connected.

4

Use the Down [▼] button to select "Front," and then use the Left and Right [◀]/[▶] buttons to select:

Sml: Select if the front speakers are small.

Lrg: Select if the front speakers are large.

Note:

- If the Subwoofer setting in step 3 is set to No, this setting is fixed at Lrg and cannot be changed.

5

Use the Down [▼] button to select "Center," and then use the Left and Right [◀]/[▶] buttons to select:

Sml: Select if the center speaker is small.

Lrg: Select if the center speaker is large.

Non: Select if no center speaker is connected.

Note:

- If the Front setting in step 4 is set to Sml, the Lrg option cannot be selected.

6

Use the Down [▼] button to select "Surr," and then use the Left and Right [◀]/[▶] buttons to select:

Sml: Select if the surround left and right speakers are small.

Lrg: Select if the surround left and right speakers are large.

Non: Select if no surround left and right speakers are connected.

Note:

- If the Front setting in step 4 is set to Sml, the Lrg option cannot be selected.

Advanced Setup—Continued

7

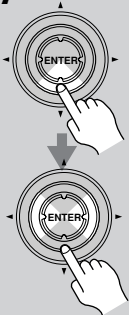

Use the Down [▼] button to select “Surr B,” and use the Left and Right [◀]/[▶] buttons to select:

- Sml:** Select if the surround back speaker is small.
- Lrg:** Select if the surround back speaker is large.
- Non:** Select if no surround back speaker is connected.

Notes:

- If the Surround setting in step 6 is set to Non, this setting does not appear.
- If the Surround setting in step 6 is set to Sml, the Lrg option cannot be selected.

8



Press the [SETUP] button.
The setup menu closes.

Notes:

- When the SP Detect function is used (page 30), these Speaker Configuration settings will change.

Crossover Frequency

To get the best bass performance from your speaker system, you need to set the crossover frequency according to the size and frequency response of your subwoofer and other speakers (front, center, and surround).

1

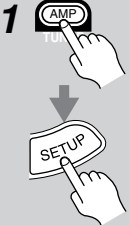

Press the REMOTE MODE [AMP] button followed by the [SETUP] button.

2

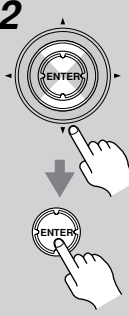

Use the Up and Down [▲]/[▼] buttons to select “1. SP Config,” and then press [ENTER].

1. SP Config

3

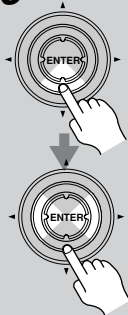

Use the Down [▼] button to select “Xover,” and then use the Left and Right [◀]/[▶] buttons to select a crossover frequency.

Choose a crossover frequency suitable for your speaker system.

If you’re using a subwoofer, choose a crossover frequency based on the diameter of your front speakers.

If you’re not using a subwoofer, use the diameter of the first speaker that you specified as Sml in steps 4 through 7 in the “Speaker configuration” settings.

Speaker cone diameter	Crossover frequency
Over 8 in. (20 cm)	60Hz
6-1/2 to 8 in. (16–20 cm)	80Hz
5-1/4 to 6-1/2 in. (13–16 cm)	100Hz (default)
3-1/2 to 5-1/4 in. (9–13 cm)	120Hz
Under 3-1/2 in. (9 cm)	150Hz

4



Press the [SETUP] button.
The setup menu closes.

Note:

- For a more accurate setting, look up the frequency response in the manuals supplied with your speakers and set accordingly. In addition, listen to some music that you know well and choose a higher crossover frequency if you think there’s not enough sound coming from the subwoofer; a lower setting if you think there’s too much.

Advanced Setup—Continued

Speaker Distance

To get the best from surround sound, it's important that the sound from each speaker reaches the listener at the same time. To achieve this, you need to specify the distance from each speaker to the listening position.

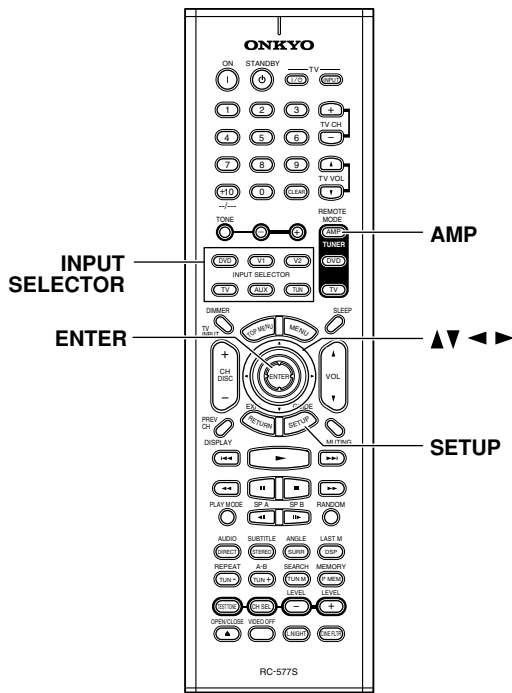

1	<p>Measure and make a note of the distance from each speaker to the listening position.</p>
2	<p>Press the REMOTE MODE [AMP] button followed by the [SETUP] button.</p>
3	<p>Use the Up and Down [▲]/[▼] buttons to select "2. SP Dist," and then press [ENTER].</p> <div style="border: 1px solid black; padding: 5px; width: fit-content; margin: 10px auto;">2. SP Dist</div>

4	<p>Use the [DISPLAY] button to select m (meters) or ft. (feet).</p> <p>m: Distances can be set from 0.3 to 9 meters in 0.3-meter steps.</p> <p>ft: Distances can be set from 1 to 30 feet in 1-foot steps.</p>
5	<p>Use the Left and Right [◀]/[▶] buttons to specify the distance for "Front," then press the Down [▼] button to select the next speaker.</p>
6	<p>Repeat step 5 for all speakers.</p> <p>Note: Speakers that you set to No or Non in the Speaker Configuration (page 48) cannot be selected.</p>
7	<p>Press the [SETUP] button.</p> <p>The setup menu closes.</p>





Notes:

- The Center and Subwoofer distances can be set up to 5 ft. (1.5 m) more or less than the Front distance. For example, if the Front distance is set to 20 ft. (6 m), the Center and Subwoofer distances can be set between 15 and 25 ft. (4.5 and 7.5 m).
- The Surr Right, Surr Left, and Surr Back distances can be set up to 5 ft. (1.5 m) more or 15 ft. (4.5 m) less than the Front distance. For example, if the Front distance is set to 20 ft. (6 m), the SurrRight, Surr Left, and Surr Back distances can be set between 5 and 25 ft. (1.5 and 7.5 m).

Advanced Setup—Continued

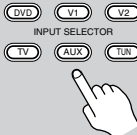
Input Source Audio Setup





Setting the Audio Input Format

<p>1</p> 	<p>Use the INPUT SELECTOR buttons to select the input source that you want to set.</p>
<p>2</p> 	<p>Press the REMOTE MODE [AMP] button followed by the [SETUP] button.</p>
<p>3</p> 	<p>Use the Up and Down [▲]/[▼] buttons to select “4.Input Set,” and then press [ENTER].</p>
<p>4</p> 	<p>Use the Up and Down buttons to select “Audio,” and then use the Left and Right [◀]/[▶] buttons to select:</p> <p>Auto: The assigned digital input (page 31) has priority over the input source’s analog input. If no digital signal is present, the analog input is used.</p> <p>Multi: The DVD multichannel input is used.</p> <p>Analog: The input source’s analog input is used even if a digital signal is present at the assigned digital input.</p>
<p>5</p> 	<p>Press the [SETUP] button. The setup menu closes.</p>

Setting the Digital Input Format

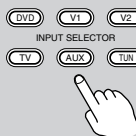
Normally, the TX-L55 detects the format of digital audio signals automatically. However, if you experience either of the following issues when playing PCM or DTS material, you may need to specify the format yourself:

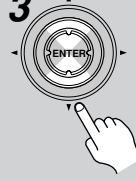
- With PCM material, if the beginnings of tracks are cut off, try setting the format to PCM.
- With DTS material, if noise is produced when fast forwarding or reversing, try setting the format to DTS.

<p>1</p> 	<p>Use the INPUT SELECTOR buttons to select the input source that you want to set.</p>
<p>2</p> 	<p>Press the REMOTE MODE [AMP] button followed by the [SETUP] button.</p>
<p>3</p> 	<p>Use the Up and Down [▲]/[▼] buttons to select “4. Input Set,” and then press [ENTER].</p>
<p>4</p> 	<p>Use the Up and Down buttons to select “Format,” and then use the Left and Right [◀]/[▶] buttons to select:</p> <p>All: PCM, Dolby Digital, and DTS formats are detected automatically. If no digital signal is present, the input source’s analog input is used.</p> <p>DTS: Select this option if playing DTS sources with the All option produces noise while the TX-L55 identifies the signal format or when fast forward or fast reverse is used. If the input signal is not DTS, nothing will be output.</p> <p>PCM: Select this option if playing a CD or other PCM source with the All option causes the tops of tracks to be cut off. If the input signal is not PCM, nothing will be output.</p>

Advanced Setup—Continued

5



Press the [SETUP] button.
The setup menu closes.

Notes:

- Select All or DTS when playing a DTS CD or LD. If you select PCM, only noise will be heard.

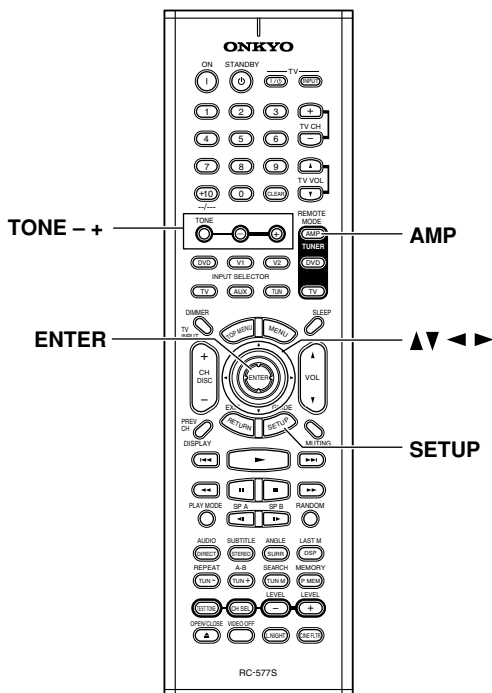

■ Adjusting on the TX-L55

1



Press the [TONE] button repeatedly to select either Bass or Treble.

2



Use the TONE [-] & [+] buttons to adjust the bass and treble.

The bass and treble can be adjusted from -12 dB to +12 dB in 2 dB steps (default 0 dB).

■ Adjusting with the Remote Controller

1



Press the REMOTE MODE [AMP] button, and then press the [TONE] button repeatedly to select either Bass or Treble.



2



Use the TONE [-] & [+] buttons to adjust the bass and treble.

The bass and treble can be adjusted from -12 dB to +12 dB in 2 dB steps (default 0 dB).

Notes:

- Always adjust the bass and treble after selecting a listening mode.
- To bypass the bass and treble tone circuits, press the [DIRECT] button to select the Direct listening mode.

Audio Adjust Functions

Adjusting the Bass & Treble

You can adjust the bass and treble of the front speakers, except when using the Direct listening mode.

If you're using the DVD multichannel input, before pressing the [TONE] button, press the REMOTE MODE [AMP] button followed by the [SURR] button so that "Tone On" appears on the display.

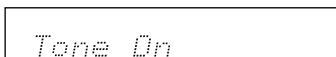



Advanced Setup—Continued

Using the Other Audio Adjust Functions

With the audio adjust functions you can tailor the sound to your personal taste.

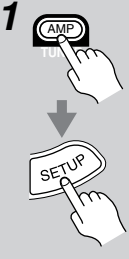
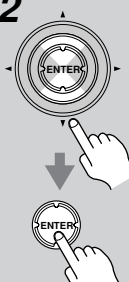
Before using the audio adjust functions, choose a listening mode first.

	<p>1 Press the REMOTE MODE [AMP] button followed by the [SETUP] button.</p>
	<p>2 Use the Up and Down [▲]/[▼] buttons to select "5. Audio Adj," and then press [ENTER].</p> <div style="border: 1px solid black; padding: 5px; width: fit-content; margin: 10px auto;">5. Audio Adj</div>
	<p>3 Use the Up and Down [▲]/[▼] buttons to select an audio adjust function, and then use the Left and Right [◀]/[▶] buttons to adjust it.</p> <p>Note that the functions available depends of the currently selected listening mode.</p>
	<p>4 Press the [SETUP] button. The setup menu closes.</p>

All of the audio adjust functions are explained below.

■ Mono In

With this function you can specify how 2-channel sources are handled in the Mono listening mode.

L+R: The front left and right speakers output a mono mix of the left and right channels (default).

L: The front left and right speakers output the sound recorded in the left channel. Use this option with material that has different languages recorded in the left and right channels.

R: The front left and right speakers output the sound recorded in the right channel. Use this option with material that has different languages recorded in the left and right channels.

■ D. Bass (Double Bass)

The Double Bass function boosts the bass by feeding bass sounds from the front left and right channels to the subwoofer. To use this function, in the Speaker Configuration, the Subwoofer setting must be set to Yes, and the Front setting must be set to Lrg (see page 48).

On: Double Bass function on.

Off: Double Bass function off.

■ L. Night (Late Night) (Dolby Digital only)

This is the same as the Late Night function on page 44. It can be used only with Dolby Digital listening mode.

■ Cine Flt (Cinema Filter)

This is the same as the CinemaFILTER function on page 44. It can be used with the following listening modes: Dolby Digital, Dolby Digital EX, Dolby Pro Logic IIx Movie, DTS, DTS-ES, DTS Neo:6 Cinema, DTS 96/24, DTS+Neo:6, and DTS+Dolby EX.

DTS Neo:6 Music Mode & Audio Adjust

This audio adjust function can be used with the DTS Neo:6 Music listening mode.

■ C Image (Center Image)

The DTS Neo:6 Music listening mode creates 6-channel surround sound from 2-channel (stereo) material. With this function you can specify by how much the front left and right channel output is attenuated in order to create the center channel. It can be adjusted from 0 to 5 (default 3)

When set to 0, the front left and right channel output is attenuated by half (–6 dB), giving the impression that the sound is located centrally. This setting works well when the listening position is considerably off center. When set to 5, the front left and right channels are not attenuated, maintaining the original stereo sound balance.

Advanced Setup—Continued

PL II & PL IIX Music Modes & Audio Adjust

The following Panorama, Dimension, and Center Width functions can be used with only the Pro Logic II Music or Pro Logic IIX Music listening mode. They cannot be adjusted if you're using the Pro Logic IIX listening mode for 6.1-channel playback from a 5.1-channel source.

■ **Panrma (Panorama)**

With this function you can broaden the width of the front stereo image when using the Pro Logic II Music or Pro Logic IIX Music listening mode.

On: Panorama function on.

Off: Panorama function off (default).

■ **Dimension**

With this function you can move the sound field forward or backward when using the Pro Logic II Music or Pro Logic IIX Music listening mode. The default setting is 3. Lower settings move the sound field forward. Higher settings move it backward.

If the stereo image feels too wide, or there's too much surround sound, move the sound field forward to improve the balance. Conversely, if the stereo image feels like it's in mono, or there's not enough surround sound, move it backward.

■ **C Width (Center Width)**

With this function you can adjust the width of the sound from the center speaker when using the Pro Logic II Music or Pro Logic IIX Music listening mode.

If you're using a center speaker, with Pro Logic II or Pro Logic IIX, the center channel sound is output by only the center speaker. (If you're not using a center speaker, the center channel sound will be distributed to the front left and right speakers to create a phantom center.) This setting controls the front left, right, and center mix, allowing you to adjust the weight of the center channel sound. It can be adjusted from 0 to 7 (default 3).

Controlling Other Components

You can use the TX-L55's remote controller (RC-575S) to control your DVD player and TV, even if it's made by another manufacturer. To do this, you first need to enter the appropriate remote control code for your DVD player and TV. Then you need to select the corresponding remote controller mode (see page 11).

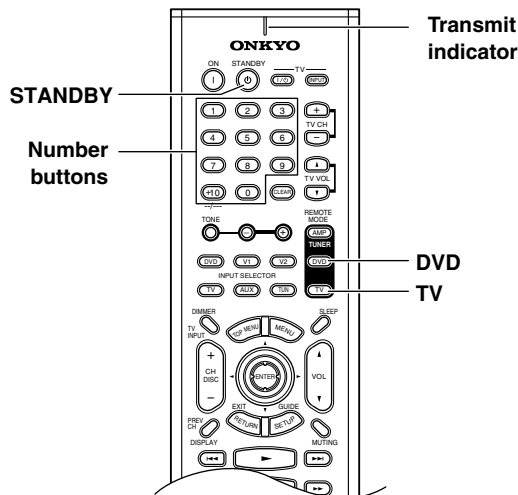

Entering Remote Control Codes

Entering the appropriate remote control code for your DVD player and TV will allow you to control them with the TX-L55's remote controller. You'll need to perform this procedure twice to enter the codes for both your DVD player and TV.

1	<p>Look up the remote control code for your DVD player or TV. See "Remote Control Codes" on page 56.</p>
2	<p>While holding down the REMOTE MODE [AMP] or [TV] button, press the [STANDBY] button.</p>

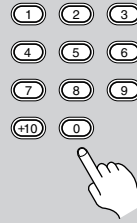
3

Within 30 seconds, use the number buttons to enter the 4-digit remote control code.

4

Select the remote controller mode, point the remote controller at your DVD player or TV, and check its operation.

Remote controller buttons that can be used with DVD mode are shown on page 12. Those that can be used with TV mode are shown on page 14.

If the remote controller doesn't work as expected, try entering the code again, or try another code.

Codes for Onkyo DVD Players

The remote control code you use for an Onkyo DVD player depends on whether it's connected via **RI**, as follows:

- 5001:** Use this code if you've connected an **RI** cable and an analog audio cable (RCA) to your DVD player. This is the default setting, so if you're using **RI**, you don't need to change anything. Point the remote controller at the TX-L55 to control the DVD player.
- 5002:** Use this code if your DVD player doesn't have an **RI** socket, or you're not using **RI**. Point the remote controller at the DVD player to control it.

Controlling Other Components—Continued

Remote Control Codes

When two or more codes are given, try each one in turn, and choose the one that works best.

Depending on the manufacturer and the component, the remote controller may not work as expected.

DVD (DVD player)	
Manufacturer	Control code
Aiwa	5010
Akai	5019
Apex	5015, 5016
CyberHome	5027
Denon	5017, 5020
GE	5003
Hitachi	5009
Integra	5001, 5002
Integra Research	5001, 5002
JVC	5023
Kenwood	5017
Magnavox	5004, 5021
Marantz	5025, 5026
Mitsubishi	5005
Onkyo	5001, 5002
Panasonic	5011, 5017, 5020
Philips	5004, 5021, 5028
Pioneer	5006
Proscan	5003
RCA	5003
Sanyo	5012
Sony	5007, 5013, 5018, 5029
Technics	5020
Thomson	5022, 5024
Toshiba	5008, 5021
Xbox	5022
Yamaha	5020
Zenith	5014, 5021

TV	
Manufacturer	Control code
Admiral	1026, 1040, 1062
Akai	1002, 1067
Akura	1045
Alba	1035, 1043
Amplivision	1063
Amstrad	1035, 1067
Amtron	1009
Anam National	1003, 1009
Anitech	1035
AOC	1004, 1005, 1006
Arc en Ciel	1066
Arcam	1063
ASA	1040
Audiovox	1009
Autovox	1040, 1068
Baird	1069
Bang & Olufsen	1040
Baur	1036, 1054, 1055, 1058, 1059, 1068
Beko	1052
Bell & Howell	1010, 1017
Binatone	1063
Blaupunkt	1041, 1042, 1044, 1058, 1059
Boots	1063
Brionvega	1040
Bruns	1040
BSR	1048
Bush	1035, 1043, 1048, 1050, 1053, 1057
Cascade	1035
Celebrity	1002
Century	1040
Cimline	1035, 1043
Citizen	1004, 1006, 1009, 1017, 1022, 1025
Clatronic	1052
Colortyme	1004, 1006
Condor	1052
Contec	1035
Contec/Cony	1007, 1009
Continental Edison	1066
Craig	1009
Crosley	1040
Crown	1009, 1014, 1035, 1052
Curtis Mathes	1001, 1004, 1006, 1010, 1017, 1022, 1025, 1034
Daewoo	1004, 1005, 1006, 1025, 1035, 1053
Daytron	1004, 1006, 1025, 1035
Decca	1067
Dimensia	1001, 1034
Dixi	1035
Dual	1057, 1068
Dumont	1004, 1039, 1040
Electroband	1002
Electrohome	1002, 1003, 1004, 1006, 1008
Elta	1035

TV	
Manufacturer	Control code
Emerson	1004, 1006, 1007, 1009, 1010, 1017, 1025, 1027, 1029, 1033, 1040, 1070
Envision	1004, 1006
Erres	1037
Europhon	1067
Fidelity	1068
Finlux	1039, 1040, 1067
Firstline	1035, 1043, 1048, 1049, 1063
Fisher	1010, 1017, 1052, 1063, 1068
Formenti	1040
Frontech	1045, 1062
Fujitsu	1070
Funai	1009, 1045, 1048, 1070
GE	1001, 1003, 1004, 1006, 1011, 1012, 1019, 1034
GEC	1038, 1063, 1067, 1069
Geloso	1035
Genexxa	1062
GoldStar	1004, 1005, 1006, 1007, 1008, 1025, 1047, 1063
Goodmans	1043, 1053, 1063
Gorenje	1052
Graetz	1062, 1069
Granada	1063, 1067
Grundig	1039, 1041, 1042, 1058, 1059, 1064
Hallmark	1004, 1006
Hanseatic	1060, 1068
Hantarex	1067
HCM	1035
Hinari	1035, 1043
Hitachi	1004, 1006, 1007, 1013, 1027, 1038, 1062, 1063, 1069
Huanyu	1053
ICE	1045, 1063
Imperial	1052
Infinity	1014
Inno Hit	1056, 1067
Interfunk	1055, 1062, 1066, 1069
Intervision	1045, 1063
ITT	1062, 1068, 1069
JBL	1014
JC Penney	1001, 1004, 1005, 1006, 1011, 1012, 1016, 1019, 1022, 1025, 1034
Jensen	1004, 1006
JVC	1007, 1012, 1013, 1015, 1033
Kaisui	1035, 1063
Kapsch	1062, 1069
Kathrein	1060
Kawasho	1002, 1004, 1006
Kendo	1043
Kenwood	1004, 1006, 1008
Kloss Novabeam	1009
Korting	1040
KTV	1009, 1025
LG	1005

Controlling Other Components—Continued

TV	
Manufacturer	Control code
Loewe	1014, 1040, 1055
Luxman	1004, 1006
LXI	1001, 1006, 1010, 1014, 1016, 1017, 1034
M Electronic	1035, 1053, 1062, 1063
Magnadyne	1040, 1067, 1068
Magnafon	1067
Magnavox	1004, 1006, 1008, 1014, 1018, 1020
Marantz	1004, 1006, 1014, 1060
Matsui	1035, 1043, 1048, 1050, 1063, 1064, 1067, 1068
Megatron	1006
Memorex	1005, 1006, 1010, 1017, 1035
Metz	1040, 1051, 1058
MGA	1004, 1005, 1006, 1008
Minerva	1039, 1058, 1059, 1064
Mitsubishi	1004, 1005, 1006, 1008, 1040, 1055, 1058
Mivar	1047, 1056, 1067
Motorola	1003, 1026
MTC	1004, 1005, 1006, 1022, 1055
Multitech	1009, 1035
NAD	1006, 1016
NEC	1003, 1004, 1005, 1006
Neckermann	1040, 1041, 1054, 1059, 1060
Nikkai	1045
Nikko	1006
Oceanic	1062
Onwa	1009
Optonica	1021, 1026
Orion	1029, 1043, 1048, 1049, 1050, 1067, 1068
Osaki	1045, 1063
Otto Versand	1036, 1041, 1043, 1054, 1055, 1058, 1059, 1060, 1063
Palladium	1052
Panasonic	1003, 1012, 1014, 1031, 1044, 1046, 1051, 1061, 1062, 1069
Pathe Marconi	1066
Philco	1003, 1004, 1005, 1006, 1007, 1008, 1014, 1018, 1040
Philips	1003, 1004, 1007, 1008, 1014, 1018, 1019, 1020, 1037, 1038, 1040, 1053, 1059, 1060
Phoenix	1040
Phonola	1037, 1040
Pioneer	1004, 1006, 1027, 1062
Portland	1004, 1005, 1006, 1025
Price Club	1022
Prism	1012
Profex	1035
Proline	1049
Proscan	1001, 1034
Protech	1035, 1045, 1063
Proton	1004, 1006, 1007
Pye	1037

TV	
Manufacturer	Control code
Quasar	1003, 1012, 1031
Quelle	1036, 1039, 1054, 1055, 1058, 1059, 1068
Radio Shack	1010, 1017, 1034
Radio Shack/ Realistic	1001, 1004, 1006, 1007, 1009, 1010, 1017, 1021, 1025
Radiola	1037
Radiomarelli	1040, 1067
RCA	1001, 1003, 1004, 1005, 1006, 1008, 1027, 1034
Realistic	1010, 1017, 1034
Rex	1045, 1062
RFT	1040
Roadstar	1035, 1045
Saba	1040, 1062, 1066, 1069
Saisho	1035, 1043, 1045, 1067, 1068
Salora	1062
Sambers	1056, 1067
Sampo	1004, 1006, 1025
Samsung	1004, 1005, 1006, 1007, 1008, 1022, 1025, 1035, 1045, 1047, 1052, 1056, 1060, 1063, 1065
Sansui	1029
Sanyo	1004, 1010, 1017
SBR	1037, 1038
Schaub Lorenz	1069
Schneider	1068
Scott	1004, 1006, 1007, 1009, 1070
Sears	1001, 1004, 1006, 1008, 1010, 1015, 1016, 1017, 1028, 1034, 1070
SEG	1045, 1063
SEI	1036, 1040, 1048, 1067, 1068
Seleco	1062
Sharp	1004, 1006, 1007, 1021, 1023, 1025, 1026
Shorai	1048
Siarem	1040, 1067
Siemens	1041, 1042, 1058, 1059
Singer	1040
Sinudyne	1036, 1040, 1043, 1067, 1068
Solavox	1062
Sonoko	1035
Sonolor	1062
Sony	1002, 1030, 1032, 1036, 1054
Soundesign	1004, 1006, 1009, 1070
Starlite	1009
Stern	1062
Sunkai	1043, 1048, 1049, 1050
Sylvania	1004, 1006, 1008, 1014, 1018, 1020
Symphonic	1009, 1028
Tandy	1026, 1062, 1063
Tashiko	1038, 1063
Tatung	1003, 1063, 1067
Tec	1063

TV	
Manufacturer	Control code
Technics	1012, 1044, 1061
Techwood	1004, 1006, 1012
Teknika	1004, 1005, 1006, 1007, 1009, 1022, 1025, 1031, 1070
Teleavia	1066
Telecaption	1024
Telefunken	1066
Teletech	1035
Teleton	1063
Tensai	1048
Thomson	1066
Thorn	1054, 1055, 1058
Toshiba	1010, 1016, 1017, 1022, 1024, 1039
Totevision	1025
Triumph	1067
Universal	1011, 1019
Universum	1045, 1052, 1058
Voxson	1040, 1062
Waltham	1063
Wards	1001, 1004, 1005, 1006, 1008, 1011, 1014, 1018, 1019, 1020, 1021, 1034, 1070
Watt Radio	1068
Wega	1040
Yamaha	1004, 1005, 1006, 1008
Yoko	1045, 1063
Zenith	1004

Controlling Other Components—Continued

Resetting the Remote Mode Buttons

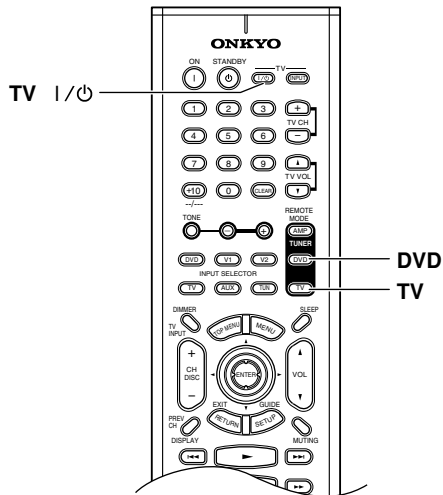

Resetting the Remote Controller

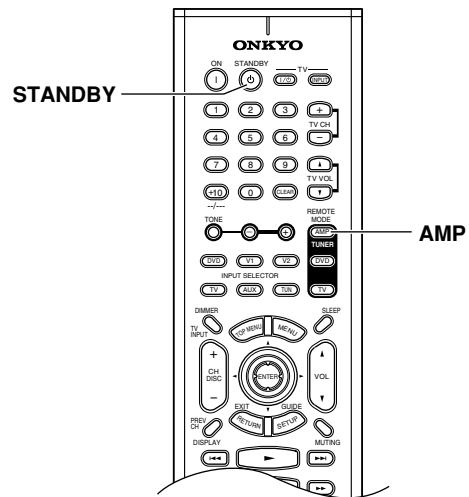

This section explains how to reset the REMOTE MODE [DVD] or [TV] button to its default control code.

1	<p>While holding down the REMOTE MODE [AMP] or [TV] button, press the TV [I/⏻] button. Release the buttons.</p>
2	<p>Press the same REMOTE MODE button again. The button is reset.</p>

This section explains how to reset the remote controller to its default settings.

1	<p>While holding down the REMOTE MODE [AMP] button, press the [STANDBY] button. Release the buttons.</p>
2	<p>Press the [AMP] mode button again. The remote controller is reset to its defaults.</p>

Notes:

- The default control code for the REMOTE MODE [DVD] button is Onkyo, 5001.
- The default control code for the REMOTE MODE [TV] button is Hitachi, 1071.

Troubleshooting

If you have any trouble using your TX-L55, look for a solution in this section. If you can't resolve the issue yourself, contact your Onkyo dealer.

Power

Can't turn on the TX-L55?

- Make sure that the power cord is properly plugged into the wall outlet.
- Unplug the power cord from the wall outlet, wait five seconds or more, then plug the cable in again.

The TX-L55 turns off as soon as it's turned on?

- The amp protection circuit has been activated. Remove the power cord from the wall outlet immediately and contact your Onkyo dealer.

Audio

There's no sound, or it's very quiet?

- Make sure that all audio connecting plugs are pushed in all the way (page 20).
- Make sure that the inputs and outputs of all components are connected properly (page 20).
- Make sure that the polarity of the speaker cables is correct and that the bare wires are in contact with metal part of each speaker terminal (page 16)
- Make sure that the input source is properly selected (page 33).
- Check the volume setting. It can be set to MIN, 1 through 79, or MAX (page 33).

The TX-L55 is designed for home theater enjoyment. It has a wide volume range, allowing precise adjustment.

- If the MUTING indicator is shown on the display, press the remote controller's [MUTING] button to unmute the TX-L55 (page 34).
- While a pair of headphones is connected to the PHONES jack, no sound is output by the speakers (page 35).
- Check the digital audio output setting on the connected component. On some games consoles, such as those that play DVDs, the default setting is off.
- With some DVD-Video discs, you need to select an audio output format from a DVD-Video disc menu.
- Make sure that the correct input signal audio format is selected (page 51).
- To use a turntable with an MC-type cartridge requires a commercially available MC phono preamp (page 28).
- Make sure that none of the connecting cables are bent, twisted, or damaged.
- Not all listening modes use all of the speakers (page 42).
- Specify the speaker distances (page 50) and adjust the individual speaker levels (page 30).

Only the front speakers produce sound?

- When the Stereo listening mode is selected, only the front speakers and subwoofer produce sound.
- When the Direct listening mode is selected, only the front speakers produce sound.
- Make sure the speakers are configured correctly (page 48).

Only the center speaker produces sound?

- If you use the Pro Logic II Movie/Music or Pro Logic IIx Movie/Music listening mode with a mono source, such as a mono TV program, the sound is concentrated in the center speaker.
- Make sure the speakers are configured correctly (page 48).

The surround speakers produce no sound?

- When the Stereo or Direct listening mode is selected, the surround speakers produce no sound (page 42).
- Depending on the source and current listening mode, not much sound may be produced by the surround speakers. Try selecting another listening mode.
- Make sure the speakers are configured correctly (page 48).

The center speaker produces no sound?

- When the Mono, Stereo, or Direct listening mode is selected, the center speaker produces no sound (page 42).
- When the Orchestra listening mode is selected, the center speaker produces no sound (page 42).
- Make sure the speakers are configured correctly (page 48).

The surround back speakers produce no sound?

- The surround back speakers are not used with all listening modes. Select another listening mode (page 39).
- Not much sound may be produced by the surround back speakers with some sources.
- If you are using a Dolby Digital EX or DTS-ES source, make sure that the Dolby Digital/DTS setting is set to On (page 43).
- Make sure the speakers are configured correctly (page 48).

The subwoofer produces no sound?

- When playing material that contains no information in the LFE channel, the subwoofer produces no sound.
- Make sure the speakers are configured correctly (page 48).

Troubleshooting—Continued

There's no sound with a certain signal format?

- Check the input signal format setting. Depending on the input source, you can select Auto, Multich, Analog, DTS, or PCM (page 51).
- Check the digital audio output setting on the source component. On some games consoles, such as those that play DVDs, the default setting is off.
- With some DVD-Video discs, you need to select an audio output format from a menu.
- Depending on the input signal, some listening modes cannot be selected (page 42).

Can't select the DTS-ES Discrete/Matrix or THX Surround EX listening modes?

- These modes cannot be selected when no surround back speakers are connected.

The volume won't go up to 79?

- When the levels of all speakers have been calibrated (page 30), the maximum volume setting may change.

Noise can be heard?

- Using cable ties to bundle audio cables with power cords, speaker cables, and so on may degrade the audio performance, so don't do it.
- An audio cable may be picking up interference. Try repositioning your cables.

The Late Night function doesn't work?

- Make sure the source material is Dolby Digital (page 44).

The DVD multichannel input doesn't work?

- Check the DVD MULTI CH IN connections (page 24).
- Set the audio input signal format to Multich (page 51).

About DTS signals

- When DTS playback finishes and the DTS bitstream stops, the TX-L55 remains in DTS listening mode and the DTS indicator remains on. This is to prevent noise when you use the pause, fast forward, or fast reverse function on your player. If you switch your player from DTS to PCM, because the TX-L55 does not switch formats immediately, you may not hear any sound, in which case you should stop your player for about three seconds, and then resume playback.
- With some CD and LD players, you won't be able to playback DTS material properly even though your player is connected to a digital input on the TX-L55. This is usually because the DTS bitstream has been processed (e.g., output level, sampling rate, or frequency response changed) and the TX-L55 doesn't recognize it as a genuine DTS signal. In such cases, you may hear noise.
- When playing DTS material, using the pause, fast forward, or fast reverse function on your player may produce a short audible noise. This is not a malfunction.

Video

There's no picture?

- Make sure that all video connecting plugs are pushed in all the way (page 20).
- Make sure that each video component is properly connected.
- The TX-L55 doesn't convert between video formats. It works as a video signal switcher. Composite video input signals are output only by the composite video output. S-Video input signals are output only by the S-Video output. And component video input signals are output only by the component video outputs.
- On your TV, make sure that the video input to which the TX-L55 is connected is selected.

Tuner

Reception is noisy, FM stereo reception is noisy, or the FM STEREO indicator doesn't appear?

- Relocate your antenna.
- Move the TX-L55 away from your TV or computer.
- Try using the AUTO FM mode (page 36).
- Passing cars and airplanes can cause interference.
- Concrete walls weaken radio signals.
- If none of the above improves reception, install an outdoor antenna.

Remote Controller

The remote controller doesn't work?

- Make sure that the batteries are installed with the correct polarity (page 7).
- Install new batteries. Don't mix different types of batteries or old and new batteries (page 7).
- Make sure that the remote controller is not too far away from the TX-L55, and that there's no obstruction between the remote controller and the TX-L55's remote control sensor (page 7).

Troubleshooting—Continued

- Make sure that the TX-L55 is not subjected to direct sunshine or inverter-type fluorescent lights. Relocate if necessary.
- If the TX-L55 is installed in a rack or cabinet with colored-glass doors, the remote controller may not work reliably when the doors are closed.
- Make sure you've selected the correct remote controller mode (page 11).
- When using the remote controller to control other manufacturers' AV components, some buttons may not work as expected.
- Make sure you've entered the correct remote control code.

Can't control other components?

- If it's an Onkyo DVD player, make sure that the **RI** cable and analog audio cable (RCA) are connected properly. Connecting only an **RI** cable won't work (page 29).
- Make sure you've selected the correct remote controller mode (pages 11, 12, and 14).

Recording

Can't record?

- On your recorder, make sure the correct input is selected.
- Digital signals cannot be recorded.

Others

The sound changes when I connect my headphones?

- When a pair of headphones is connected, the listening mode is set to Stereo, unless it's already Stereo or Direct. When you disconnect the headphones, the previous listening mode is resumed.

Can't use an audio adjust function?

- Some audio adjust functions can't be used with certain listening modes.

The speaker distance cannot be set as required?

- If the distance between the furthest and nearest speakers is greater than 20 feet (6 meters), corrected values suitable for home theater use will be set automatically (page 50).

The TX-L55 contains a microcomputer for signal processing and control functions. In very rare situations, severe interference, noise from an external source, or static electricity may cause it to lockup. In the unlikely event that this happens, unplug the power cord from the wall outlet, wait at least five seconds, and then plug it back in again.

To reset the TX-L55 to its factory defaults, turn it on and, while holding down the [◀] TUNING button, press the [STANDBY/ON] button. When the reset is complete, "Clear" appears on the display and the TX-L55 enters Standby mode.

Onkyo cannot be held responsible for damages (such as CD rental fees) due to recording failures caused by the unit malfunctioning. Before recording something important, do a trial run to make sure that everything is working properly.

Memory backup

The TX-L55 uses a battery-less memory backup system in order to retain radio presets and other settings when it's unplugged or in the case of a power failure. Although no batteries are required, it must be plugged into an AC outlet in order to charge the backup system. Once it has been charged, the TX-L55 will retain the settings for several weeks, although this depends on the environment and will be shorter in humid climates.

Specifications

Amplifier Section

Power output:	
All channels:	60 W (6 Ω , 1 kHz, DIN)
Dynamic power:	
	2 x 40 W (8 Ω , front)
THD (total harmonic distortion):	1.0% (rated power)
Damping factor:	75 (front, 1 kHz, 8 Ω)
Input sensitivity and impedance:	200 mV/47 k Ω (AUX)
Output level and impedance:	200 mV/470 Ω (REC OUT)
Frequency response:	10 Hz–60 kHz/+1.5 dB, –3 dB (AUX)
Tone control:	\pm 12 dB, 100 Hz (BASS) \pm 12 dB, 20,000 Hz (TREBLE)
S/N ratio (Direct mode):	100 dB (AUX, IHF-A)
Speaker impedance:	6 Ω – 16 Ω

Video Section

Input sensitivity, output level and impedance:	1.0 V _{p-p} /75 Ω (component and S-Video Y)
	0.7 V _{p-p} /75 Ω (component Pb/Cb, Pr/Cr)
	0.28 V _{p-p} /75 Ω (S-Video C)
	1.0 V _{p-p} /75 Ω (composite)
Component video frequency response:	5 Hz–50 MHz

Tuner Section

FM

Tuning frequency range:	87.5–108.0 MHz
Usable sensitivity:	Stereo 17.2 dBf, 2.0 μ V (75 Ω IHF) Mono 11.2 dBf, 1.0 μ V (75 Ω IHF)
S/N ratio:	Stereo 67 dB (IHF-A) Mono 70 dB (IHF-A)
FM stereo separation:	45 dB at 1 kHz

General

Power supply:	AC 230 V, 50 Hz
Power consumption:	110 W
Standby power consumption:	1.70 W
Dimensions (W x H x D):	435 x 81.5 x 378 mm
Weight:	6.5 kg

Video Inputs

Component video inputs:	2 (COMPONENT VIDEO 1, 2)
S-Video inputs:	3 (DVD, VIDEO 1, VIDEO 2)
Video inputs:	3 (DVD, VIDEO 1, VIDEO 2)

Video Outputs

Component video outputs:	1 (MONITOR)
S-Video outputs:	2 (MONITOR, VIDEO 1)
Video outputs:	2 (MONITOR, VIDEO 1)

Audio Inputs

Digital inputs:	3 (Optical 1, 2, Coaxial)
Analog inputs:	5 (AUX, VIDEO 1, VIDEO 2, TV, DVD)
Multichannel analog inputs:	1

Audio Outputs

Analog outputs:	1 (VIDEO 1)
Subwoofer pre out:	1
Speaker outputs:	6
Phones:	1

Specifications and features are subject to change without notice.

ONKYO CORPORATION

Sales & Product Planning Div. : 2-1, Nisshin-cho, Neyagawa-shi, OSAKA 572-8540, JAPAN
Tel: 072-831-8023 Fax: 072-831-8124

ONKYO U.S.A. CORPORATION

18 Park Way, Upper Saddle River, N.J. 07458, U.S.A.
Tel: 201-785-2600 Fax: 201-785-2650 <http://www.onkyousa.com>

ONKYO EUROPE ELECTRONICS GmbH

Liegnitzerstrasse 6, 82194 Groebenzell, GERMANY
Tel: +49-8142-4401-0 Fax: +49-8142-4401-555 <http://www.onkyo.net>

ONKYO CHINA LIMITED

Units 2102-2107, Metroplaza Tower I, 223 Hing Fong Road, Kwai Chung,
N.T., HONG KONG Tel: 852-2429-3118 Fax: 852-2428-9039



I0405-1

SN 29343750

(C) Copyright 2004 ONKYO CORPORATION Japan. All rights reserved.

